

Corridor Study

for

NYS Route 277 (Union Road)

NYS Route 400 to Cazenovia Creek

**Town of Lancaster
Erie County, New York**

January 2017

Project No. 36037

Prepared For:



TOWN OF
WEST SENECA
"PROUD PAST - UNLIMITED FUTURE"

1250 Union Road
West Seneca, New York 14224
Attn: Mr. Gene Hart, Councilman

Prepared By:



3495 Winton Place
Building E, Suite 110
Rochester, New York 14623

TABLE OF CONTENTS

LIST OF TABLES..... ii

LIST OF FIGURES..... ii

LIST OF APPENDICES ii

LIST OF REFERENCES ii

EXECUTIVE SUMMARY iii

I. INTRODUCTION..... I

II. LOCATION I

III. EXISTING TRAFFIC CONDITIONS I

 A. Peak Interval for Analysis 2

 B. Existing Traffic Volume Data..... 2

 C. Traffic Gap Assessment for Pedestrians..... 2

 D. Speed Study 2

 E. Field Observations..... 3

 F. Capacity Analysis..... 3

IV. FUTURE TRAFFIC CONDITIONS 5

V. PREFERRED PLAN 8

VI. CONCLUSIONS & RECOMMENDATIONS 10

VII. FIGURES..... 10

LIST OF TABLES

TABLE I	SPEED STUDY RESULTS	3
TABLE II	CAPACITY ANALYSIS RESULTS	4
TABLE III	2026 DESIGN YEAR CAPACITY ANALYSIS RESULTS	7

LIST OF FIGURES

FIGURE 1	STUDY AREA
FIGURE 2	LANE GEOMETRY AND AVERAGE DAILY TRAFFIC
FIGURE 3	PEAK HOUR VOLUMES – 2016 EXISTING CONDITIONS
FIGURE 4	PEAK HOUR VOLUMES – 2026 DESIGN CONDITIONS
FIGURE 5	GBNRTC SELECT LINK ANALYSIS
FIGURE 6	CONCEPT ROADWAY PLAN – PHASE 1
FIGURE 7	CONCEPT ROADWAY PLAN – PHASE 2
FIGURE 8	CONCEPT ROADWAY PLAN – PHASE 3

LIST OF APPENDICES

A1.	COLLECTED TRAFFIC VOLUME DATA
A2.	MISCELLANEOUS TRAFFIC DATA AND CALCULATIONS
A3.	LOS CRITERIA/DEFINITIONS
A4.	LEVEL OF SERVICE CALCULATIONS – 2016 EXISTING CONDITIONS
A5.	LEVEL OF SERVICE CALCULATIONS – 2026 FUTURE DESIGN CONDITIONS

LIST OF REFERENCES

1. HCM 2010 Highway Capacity Manual. Transportation Research Board (TRB). The National Academies, Washington, DC: 2010.
2. Road Diet Informational Guide. FHWA. 2014.
3. New York State Department of Transportation Traffic Data Viewer. 2016. Retrieved from <https://www.dot.ny.gov/tdv>.
4. Transportation Data Management System. Greater Buffalo-Niagara Regional Transportation Council (GBNRTC). Retrieved from <http://www.gbnrtc.org/maps/>. 2016.
5. Travel Demand Model. GBNRTC. 2016.

EXECUTIVE SUMMARY

OVERVIEW

The purpose of this report is to provide an assessment of existing and future traffic conditions along Union Road in the Town of West Seneca with the intent to derive near, mid, and long-term strategies and improvements to help transform Union Road into a more inviting, aesthetically pleasing, safer, multi-modal roadway; one that compliments, not competes with the adjacent land uses, both now and in the future. The study focuses on the segment of Union Road between NYS 400 and Cazenovia Creek.

Union Road is classified as a principal arterial highway under the jurisdiction of the New York State Department of Transportation (NYSDOT). As such, its primary purpose is largely to service longer vehicle trips within and through the Town of West Seneca and beyond. Today, this auto-centric roadway impacts the walkability, livability, and place-making desires of the Town, as expressed in the current Town Comprehensive Plan update. The presence of the existing Town Hall campus on Union Road, and the imminent plans for the addition of a future library to the campus, creates an even greater need for a more pedestrian-friendly, and traffic calmed roadway environment in this highway segment. The roadway needs to become more compatible with the adjoining and transforming land use and development in this town center area.

The project study area is located along Union Road between NYS 400 and Cazenovia Creek in the Town of West Seneca, Erie Count, New York. The study area consists of six (6) intersections, and the segments between, along Union Road at:

1. NYS 400-Aurora Expressway On/Off-ramp
2. Center Road (NYS Route 16)
3. Legion Parkway/Norwood Drive
4. Main Street
5. Seneca Street
6. Southgate Plaza/Willowdale Drive

The Tasks outlined in this report are as follows:

1. PM Peak Hour Turning Movement Counts & Level of Service
2. Traffic Gap Study for Pedestrians
3. Speed Study
4. Road Diet Feasibility Assessment

CONCLUSIONS & RECOMMENDATIONS

This Corridor Study provides an assessment of existing and future traffic conditions, and identifies and evaluates the potential traffic impacts that can be expected from a potential road diet of Union Road between Center Road and Seneca Street in the Town of West Seneca. The following sets forth the conclusions and recommendations based upon the results of the analyses:

- I. The existing capacity analysis results show that most the approaches, specifically those along the major north-south Union Road route, operate at LOS "D" or better during the PM peak hour. The exceptions are at the following intersections and approaches which operates at LOS "E":
 - a. Union Road/Center Road – Eastbound left
 - b. Union Road/Main Street – Eastbound left and thru/right, Westbound thru/right
 - c. Union Road/Seneca Street – Eastbound left

2. Based on the results of a PM peak period gap assessment for pedestrians and using a critical headway of 18.9 seconds, there are four (4) gaps in vehicle traffic for pedestrians to cross Union Road at Legion Parkway/Norwood Drive during the peak hour.
3. Average speeds generally operate at or below the posted speed limit (40 MPH) at the study location (Union Road at Legion Parkway). The 85th percentile speeds are three (3) to four (4) MPH higher than the posted speed limit.
4. Based on the existing and projected PM peak hour traffic volumes, ADT, GBNRTC data, and the capacity analysis results, the study segment of Union Road is not feasible for a road diet.
5. Based on traffic operations and feedback from Town of West Seneca officials, the Preferred Plan is the redevelopment of the corridor into a more pedestrian-friendly environment using a raised midblock median crossing refuge, recessed parking, landscaping, flush color contrasting medians, and consolidated driveways.

DRAFT

I. INTRODUCTION

The purpose of this report is to provide an assessment of existing and future traffic conditions along Union Road in the Town of West Seneca with the intent to derive near, mid, and long-term strategies and improvements to help transform Union Road into a more inviting, aesthetically pleasing, safer, multi-modal roadway; one that compliments, not competes with the adjacent land uses, both now and in the future. The study focuses on the segment of Union Road between NYS 400 and Cazenovia Creek.

Union Road is classified as a principal arterial highway under the jurisdiction of the New York State Department of Transportation (NYSDOT). As such, its primary purpose is largely to service longer vehicle trips within and through the Town of West Seneca and beyond. Today, this auto-centric roadway impacts the walkability, livability, and place-making desires of the Town, as expressed in the current Town Comprehensive Plan update. The presence of the existing Town Hall campus on Union Road, and the imminent plans for the addition of a future library to the campus, creates an even greater need for a more pedestrian-friendly, and traffic calmed roadway environment in this highway segment. The roadway needs to become more compatible with the adjoining and transforming land use and development in this town center area.

II. LOCATION

The project study area is located along Union Road between NYS 400 and Cazenovia Creek in the Town of West Seneca, Erie Count, New York. The study area consists of six (6) intersections, and the segments between, along Union Road at:

1. NYS 400-Aurora Expressway On/Off-ramp
2. Center Road (NYS Route 16)
3. Legion Parkway/Norwood Drive
4. Main Street
5. Seneca Street
6. Southgate Plaza/Willowdale Drive

The study area is illustrated in **Figure 1** (all Figures are included at the end of this report).

III. EXISTING TRAFFIC CONDITIONS

Union Road (NYS 277) is a north-south principal arterial type highway under the jurisdiction of the NYSDOT. Within the study area, the roadway consists of two travel lanes in each direction with a center two-way left-turn lane (TWLTL) and auxiliary lanes at the study area intersections. The roadway is 66 feet wide with five (5) foot shoulders, 11-foot travel lanes, and a 12-foot 2WLTL. The Annual Average Daily Traffic (AADT) is approximately 31,560 vehicles per day (vpd) north of Center Road and 29,689 vpd between Center Road and Seneca Street according to the most recent and available data collected by the NYSDOT in 2015. The posted speed limit is 40 miles per hour (MPH) between NYS 400 and Seneca Street; 45 MPH south of Seneca Street.

Existing AADT information was obtained from the NYSDOT [Traffic Data Viewer Website](#). **Figure 2** illustrates the AADT and lane geometry at the study area intersections.

A. Peak Design Interval for Analysis

Given the functional characteristics of the corridor (mixed-use commercial and residential), the peak hour selected for analysis is the weekday commuter PM peak period. The combination of traffic generated by the corridor's land uses and a review of the most recent and available automated traffic recorder (ATR) machine counts obtained from NYSDOT produce the greatest demand during this peak period.

B. Existing Traffic Volume Data

Turning movement traffic counts were collected by SRF & Associates on Wednesday, September 21, 2016 for the weekday commuter PM peak period between 4:00-6:00 PM at the study area intersections previously noted. The peak hour traffic periods generally occurred between 4:45-5:45 PM. The 2016 existing peak hour volumes are depicted in **Figure 3**.

C. Traffic Gap Assessment for Pedestrians

A Traffic Gap Assessment was performed at the Union Road/Legion Parkway/Norwood Drive intersection during the peak study period. Based on the location of the Town Hall campus and imminent new library, the context of the nearby neighborhoods, and our knowledge of the West Seneca community, this is a key intersection as it relates to the potential for pedestrian traffic. Transportation agencies generally establish criteria to determine the feasibility of pedestrians crossing a roadway safely and without excessive delay. A traffic gap analysis determines the gaps per minute in peak traffic periods for pedestrians to cross a particular roadway at an uncontrolled approach.

Based on the results of a PM peak period gap assessment and using a critical headway¹ of 18.9² seconds, there are four (4) gaps in vehicle traffic for pedestrians to cross Union Road during the peak hour.

1. "The critical headway is the time in seconds below which a pedestrian will not attempt to begin crossing the street. If the available headway is greater than the critical headway, it is assumed that the pedestrian will cross, but if the available headway is less than the critical headway, it is assumed that the pedestrian will not cross." Highway Capacity Manual (HCM 2010).
2. The critical headway is calculated by dividing the length of the crossing location by the average pedestrian walking speed; in this case, 66 total crossing length divided by 3.5 feet per second.

D. Speed Study

A bi-directional Speed Study was performed along Union Road at Legion Parkway/Norwood Drive to collect and evaluate speed data to determine average and 85th percentile speeds (the speed at which 85% of the traffic is traveling at or below). Speeds from a sample of 140 vehicles were collected for the northbound and southbound directions. The posted speed limit in this segment of Union Road is 40 miles per hour (MPH). **Table I** summarizes the average and 85th percentile speeds for both directions.

TABLE I
SPEED STUDY RESULTS

DIRECTION OF STUDY	AVERAGE (MPH)	85TH PERCENTILE (MPH)
Northbound	40	44
Southbound	38	43

Average speeds generally operate at or below the posted speed limit at the study location. The 85th percentile speeds are three (3) to four (4) MPH higher than the posted speed limit.

E. Field Observations

The study intersections were observed during the peak interval to assess current traffic operations. Signal timing information both collected in the field and obtained from NYSDOT for intersections within the study area were utilized to determine peak hour phasing plans and phase durations during the peak interval. This information was used to support and/or calibrate capacity analysis models described in detail later in this report.

F. Capacity Analysis

Capacity analysis is a technique used for determining a measure of effectiveness for a section of roadway and/or intersection based on the number of vehicles during a specific time period. The measure of effectiveness used for the capacity analysis is referred to as a Level of Service (LOS). Levels of Service are calculated to provide an indication of the amount of delay that a motorist experiences while traveling along a roadway or through an intersection. Since the most amount of delay to motorists usually occurs at intersections, the capacity analysis specifically focuses on intersections.

Six Levels of Service are defined for analysis purposes. They are assigned letter designations, from "A" to "F", with LOS "A" representing the best conditions and LOS "F" the worst. Suggested ranges of service capacity and an explanation of Levels of Service are included in the Appendices.

The standard procedure for capacity analysis of signalized and un-signalized intersections is outlined in the HCM 2010 published by the Transportation Research Board (TRB). Traffic analysis software, SYNCHRO 8, which is based on procedures and methodologies contained in the HCM, was used to analyze operating conditions at the study area intersections. The procedure yields a Level of Service based on the HCM as an indicator of how well intersections operate.

Capacity results for existing conditions are listed in **Table II**. The discussion following the table summarizes capacity conditions. All capacity analysis calculations are included in the Appendices.

TABLE II
CAPACITY ANALYSIS RESULTS

INTERSECTION	2016 EXISTING CONDITIONS
	PM
Union Road/NYS 400 (S)	
Eastbound left/right – NYS 400	C(22.3)
Eastbound right – NYS 400	B(18.7)
Northbound left – Union Road	C(34.3)
Northbound thru – Union Road	C(24.7)
Southbound thru – Union Road	C(34.8)
Southbound right – Union Road	A(5.5)
Overall LOS	C(25.5)
Union Road/Center Road (S)	
Eastbound left – Center Road	E(68.1)
Eastbound thru/right – Center Road	D(42.7)
Westbound left – Center Road	D(54.2)
Westbound thru/right – Center Road	D(46.6)
Northbound left – Union Road	C(21.2)
Northbound thru/right – Union Road	C(20.2)
Southbound left – Union Road	B(19.6)
Southbound thru/right – Union Road	C(25.5)
Overall LOS	C(28.8)
Union Road/Norwood Drive (U)	
Westbound – Norwood Drive	C(19.4)
Southbound left – Union Road	B(11.0)
Union Road/Legion Parkway (U)	
Eastbound – Legion Parkway	D(34.8)
Northbound left – Union Road	B(14.3)
Union Road/Main Street (S)	
Eastbound left – Main Street	E(58.3)
Eastbound thru/right – Main Street	E(72.3)
Westbound left – Main Street	D(53.0)
Westbound thru/right – Main Street	E(76.7)
Northbound left – Union Road	B(12.9)
Northbound thru/right – Union Road	B(15.8)
Southbound left – Union Road	B(13.1)
Southbound thru/right – Union Road	B(12.9)
Overall LOS	C(20.6)
Union Road/Seneca Street (S)	
Eastbound left – Seneca Street	E(72.8)
Eastbound thru/right – Seneca Street	D(54.7)
Westbound left – Seneca Street	D(52.7)
Westbound thru/right – Seneca Street	D(54.7)
Northbound left – Union Road	C(26.4)
Northbound thru/right – Union Road	C(23.1)

INTERSECTION	2016 EXISTING CONDITIONS
	PM
Southbound left – Union Road	B(15.3)
Southbound thru/right – Union Road	C(30.9)
Overall LOS	D(37.0)
Union Road/Southgate Plaza/Willowdale Drive (S)	
Eastbound left – Southgate Plaza	D(45.4)
Eastbound thru/right – Southgate Plaza	B(14.8)
Westbound – Willowdale Drive	D(45.9)
Northbound left – Union Road	A(8.7)
Northbound thru/right – Union Road	B(13.2)
Southbound left – Union Road	A(9.7)
Southbound thru/right – Union Road	B(17.3)
Overall LOS	B(17.1)

Notes:

1. A(7.9) = LOS(Delay in seconds per vehicle)
2. (S) = Signalized; (U) = Un-signalized

The capacity analysis results show that most the approaches, specifically those along the major north-south Union Road route, operate at LOS “D” or better during the PM peak hour. The exceptions are at the following intersections and approaches which operates at LOS “E”:

- Union Road/Center Road – Eastbound left
- Union Road/Main Street – Eastbound left and thru/right, Westbound thru/right
- Union Road/Seneca Street – Eastbound left

IV. FUTURE TRAFFIC CONDITIONS

The next step in the study involved the investigation of performing a road diet along Union Road within the study corridor. A road diet “involves converting an existing four-lane undivided roadway segment to a three-lane segment consisting of two through lanes and a center [TWLTL]. The reduction of lanes allows the roadway cross section to be reallocated for other uses such as bike lanes, pedestrian refuge islands, transit stops, or parking. (Federal Highway Administration [FHWA] Road Diet Informational Guide, 2014.” In this case, the existing TWLTL would be retained with the travel lanes being reallocated.

Consideration for implementing a road diet along Union Road in this segment is the result of several factors and benefits, including improved safety and livability; improved operations; and benefits for pedestrians and bicyclists.

In addition to the potential benefits of a road diet, the feasibility of establishing such a treatment was reviewed. This study obtained the most recent and available Average Daily Traffic (ADT) information measured by NYSDOT. Transportation agencies, such as NYSDOT, use ADT as a good first approximation of whether to consider a road diet treatment. Per the Federal Highway Administration Road Diet Information Guide, road diets have been documented with ADTs from 8,500 vpd to 24,000 vpd; the FHWA advises that roadways with 20,000 vpd may be a good candidate.

In the case of Union Road within the study segment, the ADT is approximately 29,689 vpd. Next, peak hour directional volumes were reviewed. The following chart depicts the peak hour directional volumes at each of the study intersections. The green shaded area illustrates the feasible threshold at which a road diet could be further considered.

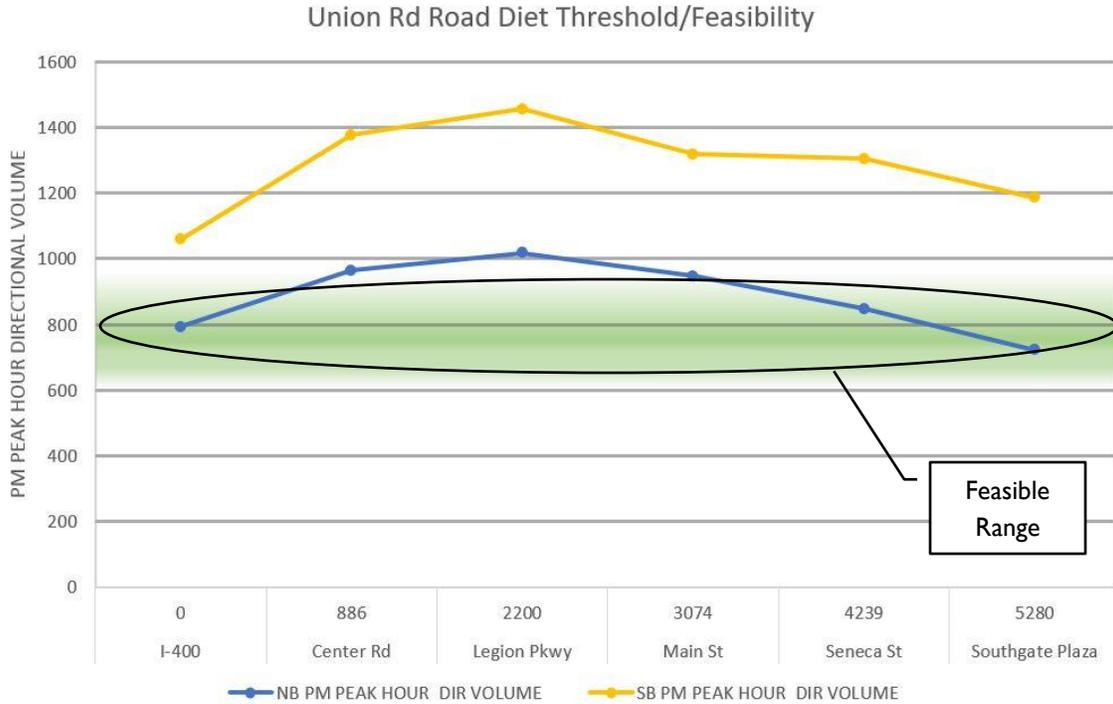

Using the information highlighted in the previous chart, peak hour directional traffic volumes are generally significantly higher than is recommended.

The extent of the conceptual road diet extends from approximately 600 feet south of Center Road to 600 feet north of Seneca Street. For roadway projects, such as this one, a design year is used to project future traffic volumes. A 10-year projection was used for this project using a 0.69% per year growth applied to the study intersections. This growth rate was obtained from the regional Travel Demand Model for the roadway, as supplied by the Greater Buffalo-Niagara Regional Transportation Council (GBNRTC). **Figure 4** illustrates the 2026 design year conditions. The following table depicts the LOS results for the corridor with and without a road diet in place. With the road diet in place, no change in LOS is projected at the intersections of Union Road at NYS 400, Seneca Street, and Southgate Plaza/Willdowdale Drive.

TABLE III
2026 DESIGN YEAR CAPACITY ANALYSIS
RESULTS

INTERSECTION	2026 DESIGN CONDITIONS	2026 DESIGN CONDITIONS w/ ROAD DIET
	PM	PM
Union Road/NYS 400 (S)		
Eastbound left/right – NYS 400	C(24.4)	No Change in LOS
Eastbound right – NYS 400	C(20.1)	
Northbound left – Union Road	D(43.7)	
Northbound thru – Union Road	C(25.6)	
Southbound thru – Union Road	D(41.5)	
Southbound right – Union Road	A(5.9)	
Overall LOS	C(29.2)	
Union Road/Center Road (S)		
Eastbound left – Center Road	E(69.1)	E(69.1)
Eastbound thru/right – Center Road	D(43.7)	D(43.7)
Westbound left – Center Road	D(53.6)	D(53.6)
Westbound thru/right – Center Road	D(48.9)	D(48.9)
Northbound left – Union Road	C(30.7)	C(21.9)
Northbound thru/right – Union Road	C(25.3)	D(42.6)
Southbound left – Union Road	C(31.9)	C(31.9)
Southbound thru/right – Union Road	C(30.1)	C(30.1)
Overall LOS	C(33.6)	D(38.3)
Union Road/Norwood Drive (U)		
Westbound – Norwood Drive	C(21.6)	E(38.6)
Southbound left – Union Road	B(11.4)	B(11.4)
Union Road/Legion Parkway (U)		
Eastbound – Legion Parkway	E(41.0)	F(64.6)
Northbound left – Union Road	C(15.4)	C(15.3)
Union Road/Main Street (S)		
Eastbound left – Main Street	E(60.9)	E(61.4)
Eastbound thru/right – Main Street	E(76.8)	E(77.5)
Westbound left – Main Street	D(54.2)	D(54.4)
Westbound thru/right – Main Street	E(76.2)	E(72.3)
Northbound left – Union Road	B(17.4)	E(61.8)
Northbound thru/right – Union Road	B(15.4)	F(87.1)
Southbound left – Union Road	B(18.8)	F(*)
Southbound thru/right – Union Road	B(11.6)	F(*)
Overall LOS	C(20.6)	F(119.7)
Union Road/Seneca Street (S)		
Eastbound left – Seneca Street	F(85.4)	No Change in LOS
Eastbound thru/right – Seneca Street	E(57.1)	
Westbound left – Seneca Street	E(57.5)	
Westbound thru/right – Seneca Street	D(53.6)	
Northbound left – Union Road	D(43.8)	

INTERSECTION	2026 DESIGN CONDITIONS	2026 DESIGN CONDITIONS w/ ROAD DIET
	PM	PM
Northbound thru/right – Union Road	C(24.8)	
Southbound left – Union Road	B(17.4)	
Southbound thru/right – Union Road	D(35.3)	
Overall LOS	D(41.1)	
Union Road/Southgate Plaza/Willowdale Drive (S)		
Eastbound left – Southgate Plaza	D(46.7)	No Change in LOS
Eastbound thru/right – Southgate Plaza	B(14.8)	
Westbound – Willowdale Drive	D(50.6)	
Northbound left – Union Road	B(13.3)	
Northbound thru/right – Union Road	B(13.2)	
Southbound left – Union Road	A(9.9)	
Southbound thru/right – Union Road	B(17.9)	
Overall LOS	B(17.8)	

Between 2026 Design Conditions and 2026 Design Conditions with a Road Diet, the projected LOS degrades the northbound thru/right approach at Union Road/Center Road from “C” to “D”. The following approaches also degrade between these conditions:

- Union Road/Norwood Drive – Westbound (“C” to “E”)
- Union Road/Legion Parkway – Eastbound (“E” to “F”)
- Union Road/Main Street – Northbound left (“B” to “E”), Northbound thru/right (“B” to “F”), Southbound left (“B” to “F”), Southbound thru/right (“B” to “F”), Overall LOS (“C” to “F”)

In addition to this preceding analysis, GBNRTC was consulted to develop Select Link Analyses along the study corridor based on the Regional Travel Demand Model. **Figure 5** illustrates a Select Link Analysis between NYS 400 and East & West Road. The figure depicts the percent difference in modeled ADT post capacity change (downgrading from four lanes to two lanes with a TWLTL). An approximate 10.5% decrease in ADT is expected. Based on the ADT of Union Road (approximately 29,689 vpd), the resulting ADT would be approximately 26,571 vpd; nearly 7,000-10,000 vpd higher than comparable road diet roadways.

Therefore, based on the peak hour traffic volumes, ADT, GBNRTC data, and the capacity analysis results, the study segment of Union Road is not feasible for a road diet.

V. PREFERRED PLAN

Although a road diet is not feasible for the study corridor, Union Road is still a candidate for other treatments that enhance pedestrian safety and for making it a more inviting and economically viable corridor for all users. **Figures 6 through 8** illustrate the recommended phasing of the preferred plan.

Phase 1 (Figure 6)

Figure 5 depicts Phase 1 of the Plan. Recommended improvements include installing flush color contrasting medians in the segments between Center Road and Legion Parkway, and between Main Street and Seneca Street. These do not impact the capacity of Union Road, but seek to enhance the aesthetic appeal of the corridor. The medians have the potential to reduce vehicle speeds as they provide a visual narrowing element in their segments.

Concurrent with the medians is the restriping of Union Road to narrow the inside travel lanes. The current curb-to-curb width is 66 feet with five (5)-foot shoulders, 11-foot travel lanes, and a 12-foot TWLTL. The restriping would narrow the inside travel lanes to 10 feet and increase the shoulders to six (6) feet. Heavy vehicle percentages in the study segment are less than 3% in either direction, thus the inside 10-foot travel lanes would not adversely impact existing heavy vehicle traffic.

Along the west side of Union Road between Legion Parkway and Main Street, recessed on-street parking is recommended. The total width of the on-street parking would be 10 feet including a two (2)-foot buffer. The on-street parking will help buffer vehicle traffic from the adjacent sidewalk pedestrian traffic, and create convenient parking for visitors to the new library.

Within this same block, a mid-block pedestrian crossing should be installed with a raised pedestrian refuge island. Mid-block crossings are generally not used on roadways, such as Union Road, that carry the volume of traffic it does. However, the NYSDOT [Highway Design Manual \(HDM\)](#) states that on roadways with volumes and speeds similar to Union Road, marked crosswalks alone are not sufficient, and “other substantial improvements to provide safe pedestrian crossing” should be considered. Coupled with a curb extension at the crossing location on the west side, pedestrians can cross Union Road one approach at a time, thus increasing the availability of crossing opportunities.

Additionally, the existing distance between crosswalks in this segment is approximately 880 feet. Desired distances are generally between 330-500 feet in central business districts (NYSDOT HDM). The Institute of Transportation Engineer’s (ITE) [Designing Walkable Urban Thoroughfares](#) report states that “if the block length exceeds 400 feet” midblock crossings should be considered.

The midblock crossing location should be enhanced, aside from the pedestrian refuge, with a Rectangular Rapid Flashing Beacon (RRFB) warning sign or a potential High-Intensity Activated crossWalk (HAWK) treatment.

Ultimately, the new crosswalk seeks to provide a more convenient crossing location for residents east of Union Road to access the Town Hall Campus and new library.

A new access road should be constructed at the southern point of Fremont Avenue and continue towards Norwood Drive. This new road, coupled with a potential spur onto Union Road from the east-west portion of Fremont Avenue, seeks to encourage the redevelopment of fronting Union Road parcels in a more access controlled manner (i.e., Access Management principles).

Phase 2 (Figure 7)

A new access road should be installed between Norwood Drive and Main Street with a spur onto Union Road to continue the strategy of consolidating access for the properties fronting Union Road. Over time as the properties redevelop, unified access and parking is desired to improve pedestrian and vehicle safety and operations.

The consolidation of properties along the east side of Union Road will allow for a larger raised median to visually improve the segment, reduce vehicle speeds, and improve vehicle operations.

Phase 3 (Figure 8)

The last phase illustrates the further redevelopment of the properties along the east side of Union Road. This segment of Union Road now exhibits pedestrian-oriented design that seeks to transform the corridor to a more multi-modal friendly experience. The fronting buildings create a street wall that provides definition and enclosure to pedestrians. Meanwhile for drivers, it offers a visual experience that conveys a more urban feel, thus slowing vehicle speeds and improving safety.

VI. CONCLUSIONS & RECOMMENDATIONS

This Corridor Study provides an assessment of existing and future traffic conditions, and identifies and evaluates the potential traffic impacts that can be expected from a potential road diet of Union Road between Center Road and Seneca Street in the Town of West Seneca. The following sets forth the conclusions and recommendations based upon the results of the analyses:

1. The existing capacity analysis results show that most the approaches, specifically those along the major north-south Union Road route, operate at LOS “D” or better during the PM peak hour. The exceptions are at the following intersections and approaches which operates at LOS “E”:
 - a. Union Road/Center Road – Eastbound left
 - b. Union Road/Main Street – Eastbound left and thru/right, Westbound thru/right
 - c. Union Road/Seneca Street – Eastbound left
2. Based on the results of a PM peak period gap assessment for pedestrians and using a critical headway of 18.9 seconds, there are four (4) gaps in vehicle traffic for pedestrians to cross Union Road at Legion Parkway/Norwood Drive during the peak hour.
3. Average speeds generally operate at or below the posted speed limit (40 MPH) at the study location (Union Road at Legion Parkway). The 85th percentile speeds are three (3) to four (4) MPH higher than the posted speed limit.
4. Based on the existing and projected PM peak hour traffic volumes, ADT, GBNRTC data, and the capacity analysis results, the study segment of Union Road is not feasible for a road diet.
5. Based on traffic operations and feedback from Town of West Seneca officials, the Preferred Plan is the redevelopment of the corridor into a more pedestrian-friendly environment using a raised midblock median crossing refuge, recessed parking, landscaping, flush color contrasting medians, and consolidated driveways.

VII. FIGURES

Figures 1 through 8 are included on the following pages.

FIGURE 1 - STUDY AREA

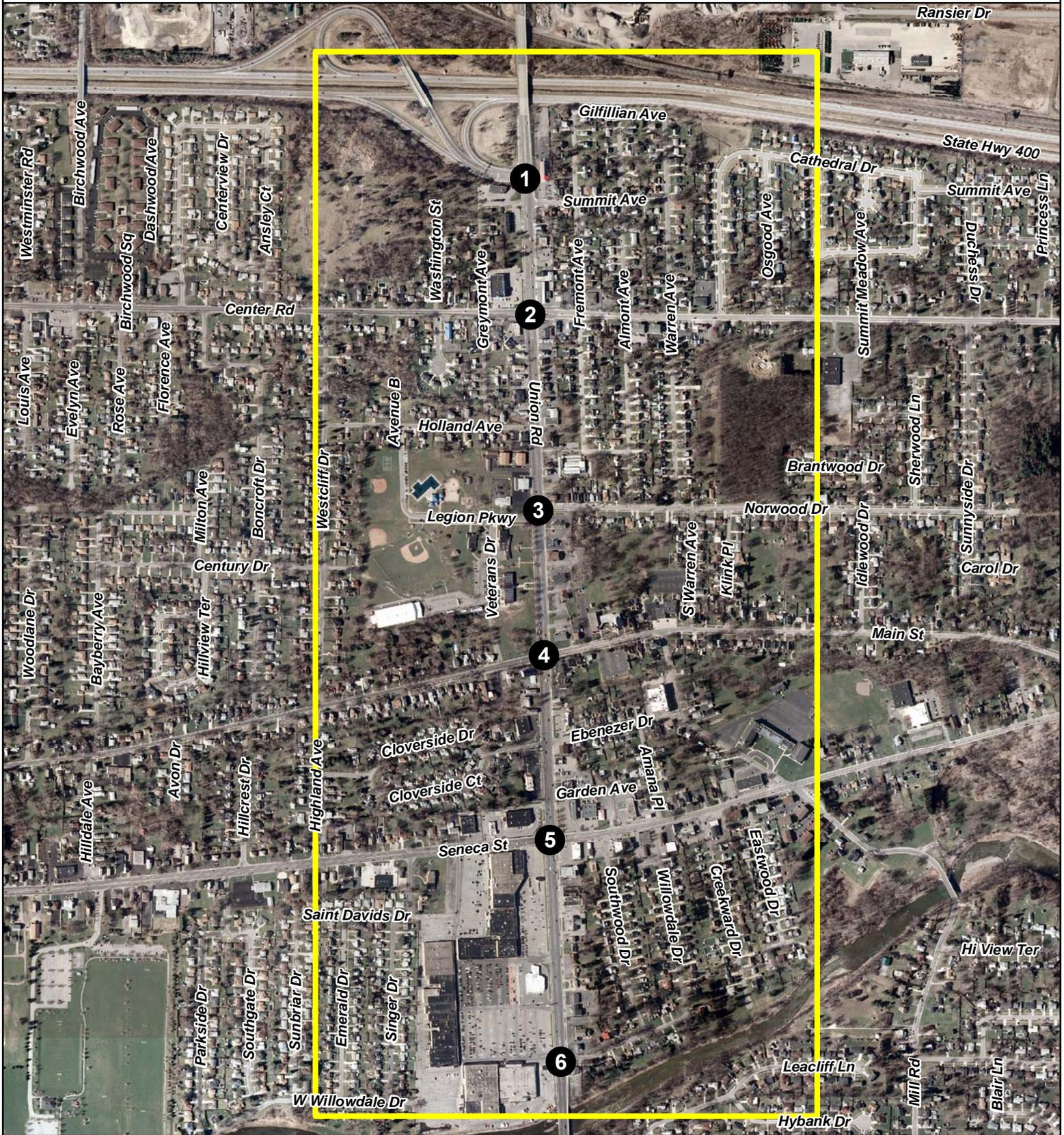

Legend

- Study Intersection
- ▭ Study Area

UNION ROAD (NYS 277) CORRIDOR STUDY

TOWN OF WEST SENECA, NY

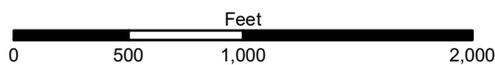

Note: All counts by New York State Dept of Transportation
 V.P.D. = Vehicles Per Day

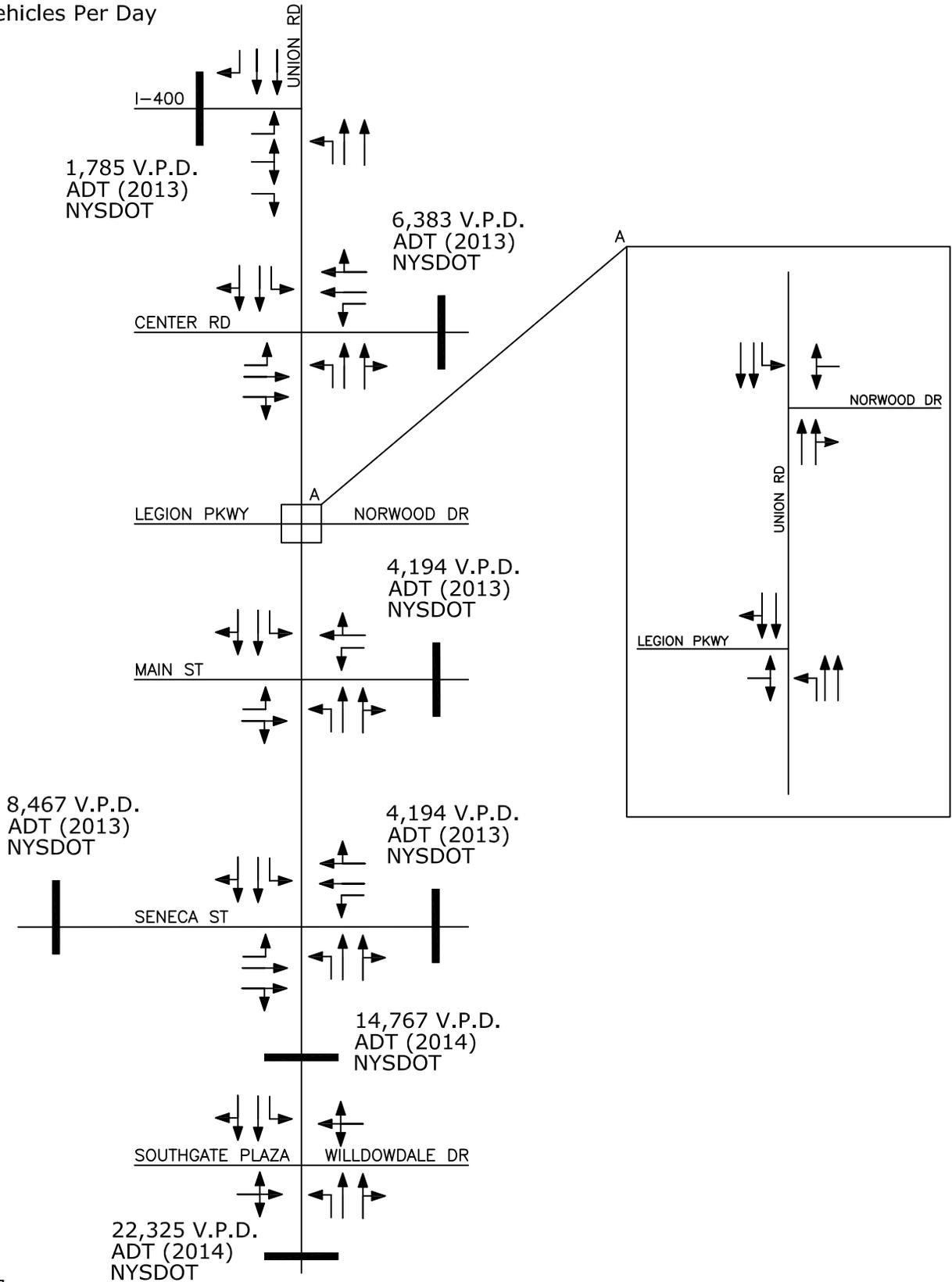

PROJECT NO: 36037

KEY



N

NOT TO SCALE

FIGURE 2

LANE GEOMETRY &
 AVERAGE DAILY TRAFFIC

UNION ROAD (NYS 277) CORRIDOR STUDY
 TOWN OF WEST SENECA, NY



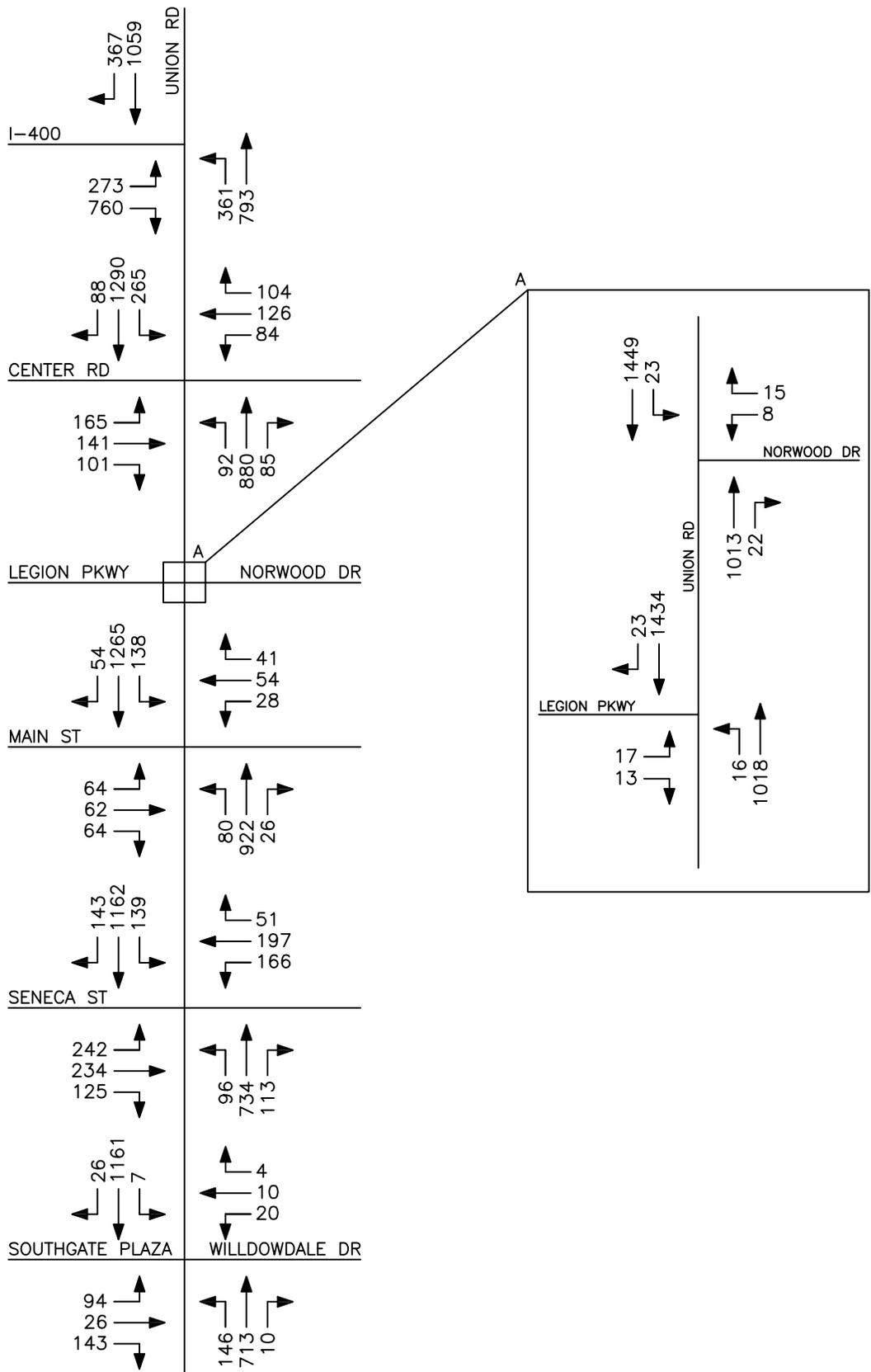

PROJECT NO: 36037

KEY

00 = PM



N

NOT TO SCALE

FIGURE 3

PEAK HOUR VOLUMES
2016 EXISTING CONDITIONS

UNION ROAD (NYS 277) CORRIDOR STUDY
TOWN OF WEST SENECA, NY

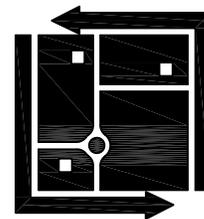

SRF
ASSOCIATES

WWW.SRFA.NET

Transportation Engineering & Planning Consultants

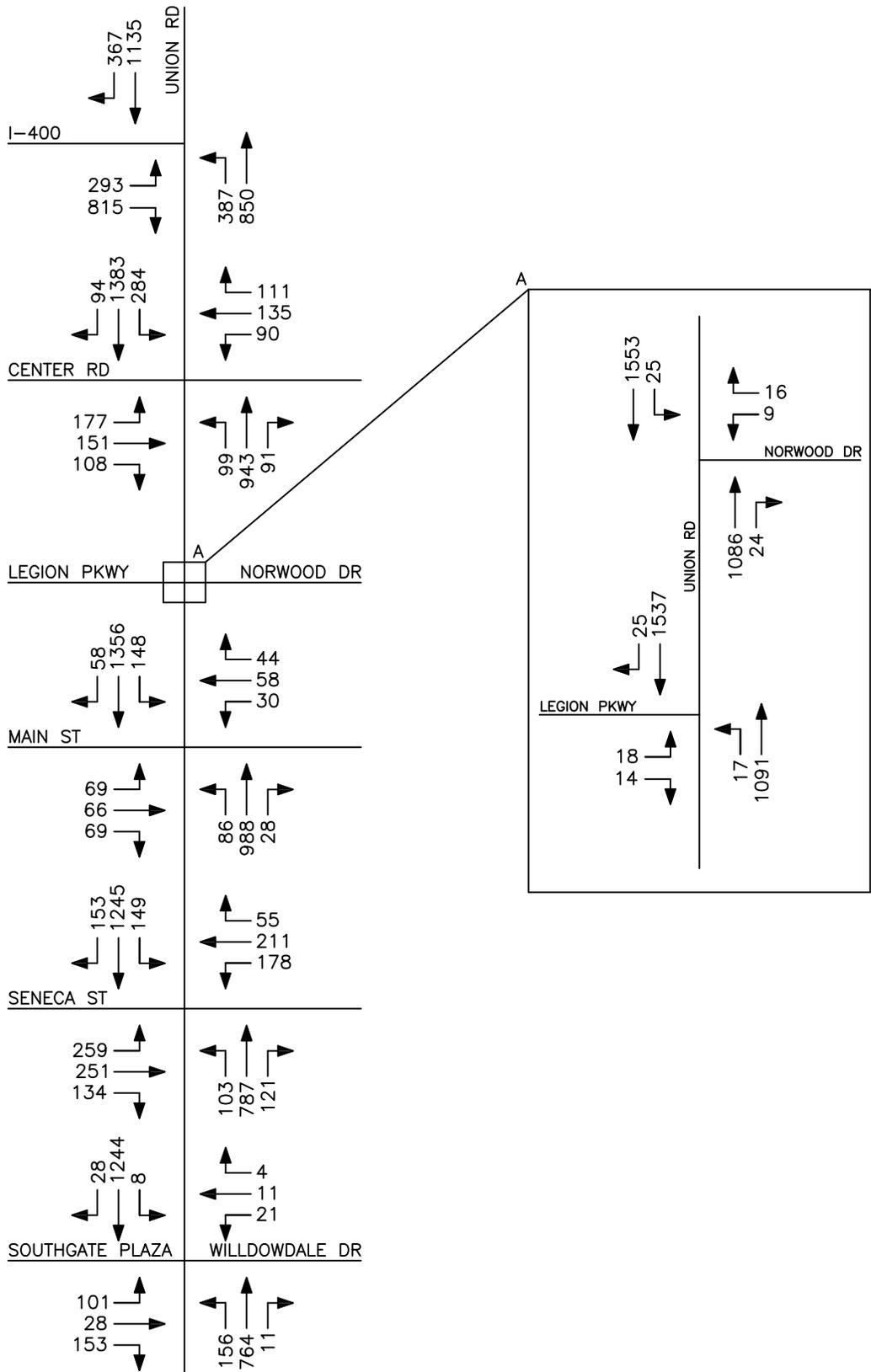

PROJECT NO: 36037

KEY

00 = PM



N

NOT TO SCALE

FIGURE 4

PEAK HOUR VOLUMES
2026 DESIGN CONDITIONS

UNION ROAD (NYS 277) CORRIDOR STUDY
TOWN OF WEST SENECA, NY

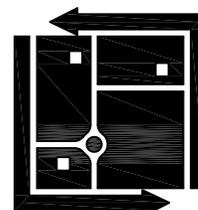

SRF
ASSOCIATES

WWW.SRFA.NET

Transportation Engineering & Planning Consultants

FIGURE 5 - SELECT LINK ANALYSIS

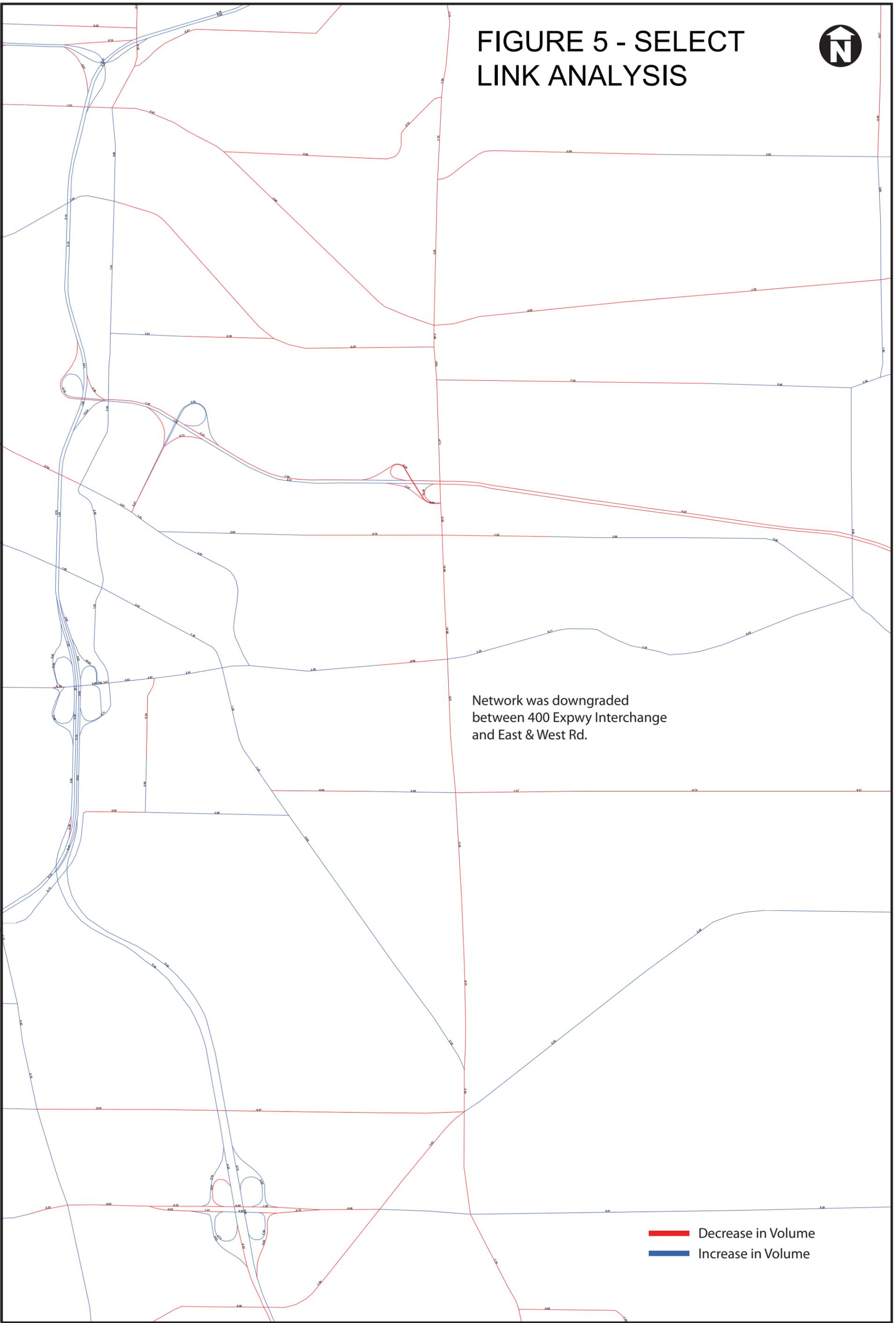

Network was downgraded
between 400 Expwy Interchange
and East & West Rd.

— Decrease in Volume
— Increase in Volume

PROJECT: Union Road, Rt 400 - Cazenovia Creek
Percent Difference in Modeled ADT Volumes - Post Capacity Change (Downgrade from 4 lanes to 2 lanes w/ center turn lane)
SOURCE: GBNRTC Regional Travel Demand Model
DATE: October 2016



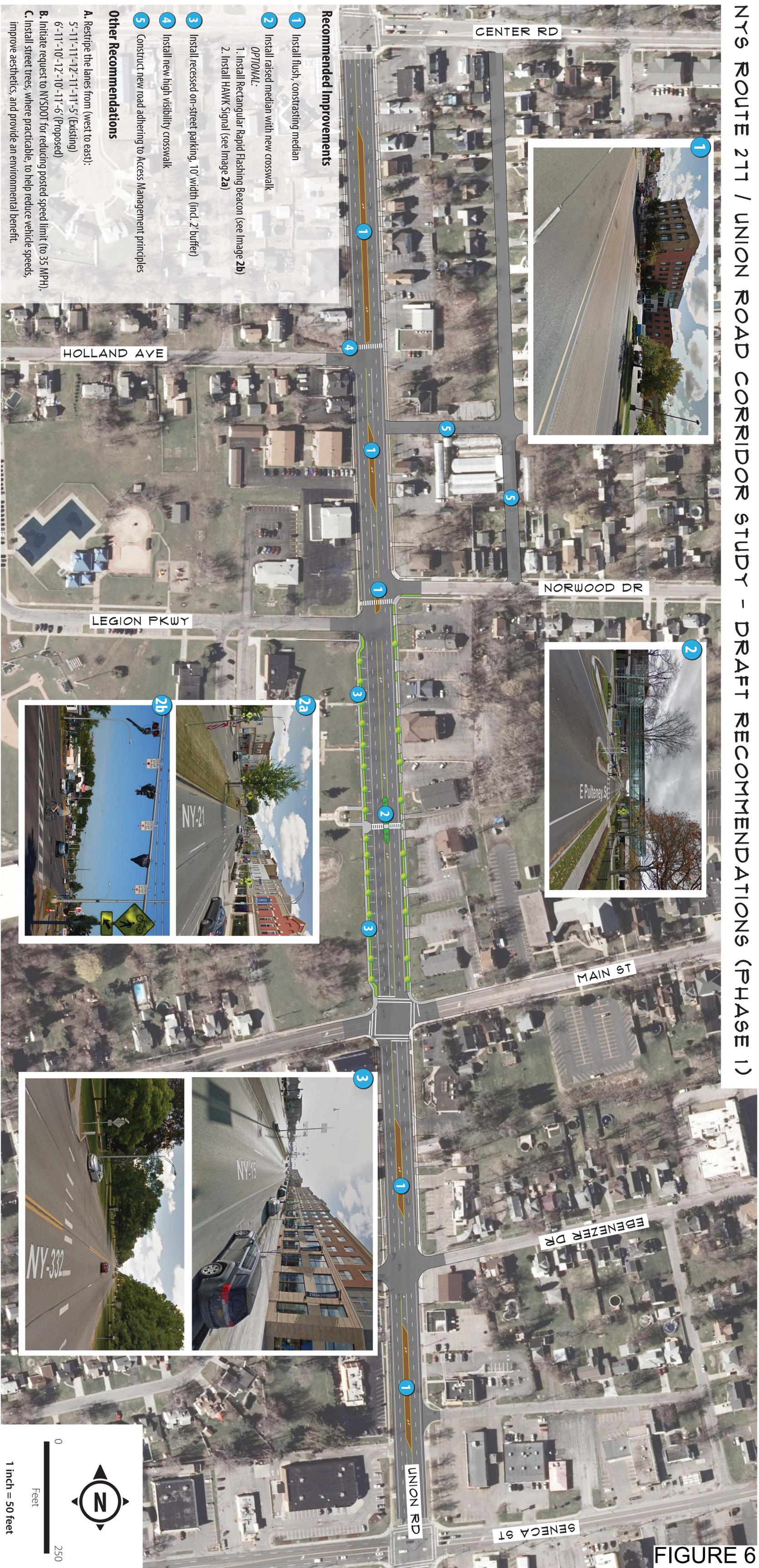

FIGURE 6

Recommended Improvements

- 1 Install flush, contrasting median
- 2 Install raised median with new crosswalk
OPTIONAL:
1. Install Rectangular Rapid Flashing Beacon (see Image 2a)
2. Install HAWK Signal (see Image 2a)
- 3 Install recessed on-street parking, 10' width (incl. 2' buffer)
- 4 Install new high visibility crosswalk
- 5 Construct new road adhering to Access Management principles

Other Recommendations

- A. Restripe the lanes from (west to east):
5'-11"-11'-12'-11'-11'-5" (Existing)
6'-11"-10'-12'-10'-11'-6" (Proposed)
- B. Initiate request to NYS DOT for reducing posted speed limit (to 35 MPH).
- C. Install street trees, where practicable, to help reduce vehicle speeds, improve aesthetics, and provide an environmental benefit.

HOLLAND AVE

CENTER RD

NORWOOD DR

LEGION PKWY

MAIN ST

EBENEZER DR

UNION RD

SENECA ST



1 inch = 50 feet

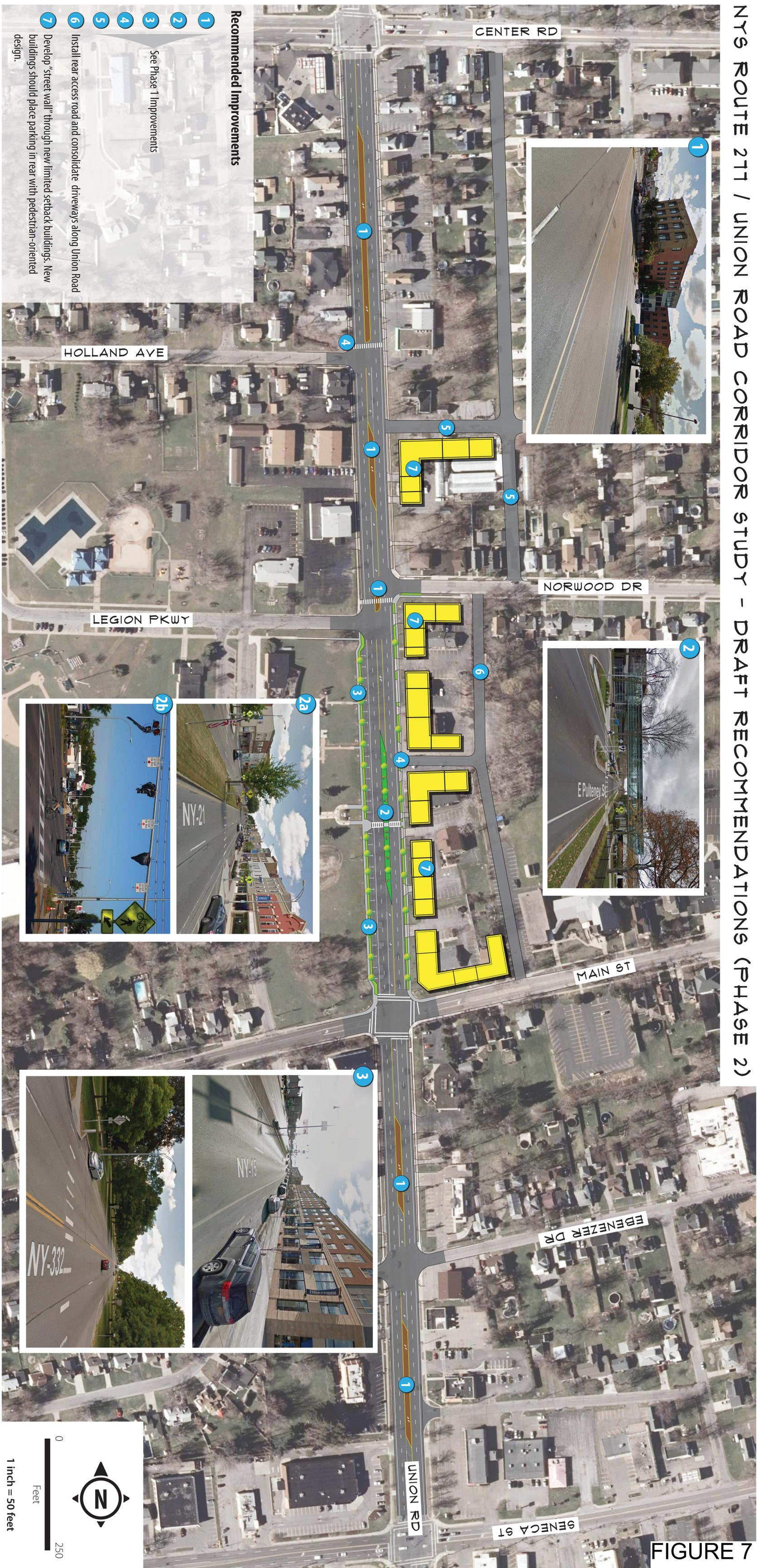

Recommended Improvements

- 1 See Phase 1 Improvements
- 2
- 3
- 4
- 5
- 6 Install rear access road and consolidate driveways along Union Road
- 7 Develop "street wall" through new limited setback buildings. New buildings should place parking in rear with pedestrian-oriented design.

FIGURE 7



FIGURE 8



1 inch = 50 feet

APPENDICES

A1

Collected Traffic Volume Data

Start Time	Union Road Southbound			Union Road Northbound			Westbound			Eastbound			Int. Total	
	Right	Thru	Left	Right	Thru	Left	Right	Thru	Left	Right	Thru	Left		
04:00 PM	108	259	0	0	0	0	178	60	0	163	0	77	0	845
04:15 PM	102	246	0	0	0	0	215	92	0	185	0	75	0	915
04:30 PM	131	220	0	0	0	0	179	94	0	164	0	92	0	880
04:45 PM	76	261	0	0	0	0	199	93	0	202	0	71	0	902
Total	417	986	0	0	0	0	771	339	0	714	0	315	0	3542
05:00 PM	104	286	0	0	0	0	206	93	0	208	0	82	0	979
05:15 PM	112	289	0	0	0	0	185	97	0	172	0	57	0	912
05:30 PM	75	223	0	0	0	0	203	78	0	281	0	63	0	821
05:45 PM	77	273	0	0	0	0	189	77	0	176	0	44	2	787
Total	368	1071	0	0	0	0	783	345	0	683	0	246	2	3499
Grand Total	785	2057	0	0	0	0	1554	684	0	1397	0	561	2	7041
Approach %	27.6	72.4	0	0	0	0	69.4	30.6	0	71.3	0	28.6	0.1	
Total %	11.1	29.2	0	0	0	0	22.1	9.7	0	19.8	0	8	0	
Unshifted	785	2057	0	0	0	0	1554	684	0	1397	0	561	2	7041
% Unshifted	100	100	0	0	0	0	100	100	0	100	0	100	100	100
Bank 1	0	0	0	0	0	0	0	0	0	0	0	0	0	0
Bank 2	0	0	0	0	0	0	0	0	0	0	0	0	0	0
% Bank 1	0	0	0	0	0	0	0	0	0	0	0	0	0	0
% Bank 2	0	0	0	0	0	0	0	0	0	0	0	0	0	0

Start Time	Union Road Southbound			Union Road Northbound			Westbound			Eastbound			Int. Total		
	Right	Thru	Left	Right	Thru	Left	Right	Thru	Left	Right	Thru	Left			
04:45 PM	76	261	0	0	0	0	199	93	0	292	202	0	71	0	273
05:00 PM	104	286	0	0	0	0	206	93	0	299	208	0	82	0	290
05:15 PM	112	289	0	0	0	0	185	97	0	282	172	0	57	0	229
05:30 PM	75	223	0	0	0	0	203	78	0	281	178	0	63	0	241
Total	367	1059	0	0	0	0	793	361	0	1154	760	0	273	0	1033
% App. Total	25.7	74.2	0	0	0	0	65.7	34.3	0	73.6	26.4	0	28.4	0	36.14
Unshifted	367	1059	0	0	0	0	100	100	0	100	100	0	100	0	100
% Unshifted	100	100	0	0	0	0	100	100	0	100	100	0	100	0	100
Bank 1	0	0	0	0	0	0	0	0	0	0	0	0	0	0	0
Bank 2	0	0	0	0	0	0	0	0	0	0	0	0	0	0	0
% Bank 1	0	0	0	0	0	0	0	0	0	0	0	0	0	0	0
% Bank 2	0	0	0	0	0	0	0	0	0	0	0	0	0	0	0

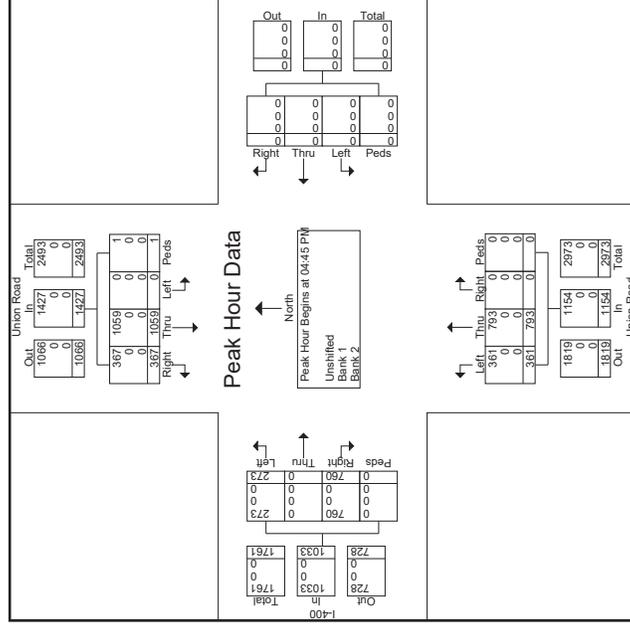

Start Time	UNION RD Southbound			CENTER RD Westbound			UNION RD Northbound			CENTER RD Eastbound			Int. Total				
	Right	Thru	Left	Right	Thru	Left	Right	Thru	Left	Right	Thru	Left					
04:00 PM	33	323	53	2	32	27	19	3	23	213	16	0	23	32	41	0	840
04:15 PM	23	271	89	0	25	37	16	0	12	248	21	1	26	34	42	1	846
04:30 PM	21	235	60	1	34	24	24	0	12	212	23	0	40	50	44	1	781
04:45 PM	24	324	76	0	18	33	22	0	19	249	23	0	24	28	41	0	881
Total	101	1153	278	3	109	121	81	3	66	922	83	1	113	144	168	2	3348
05:00 PM	21	362	75	0	31	20	20	0	21	208	17	0	30	28	53	1	877
05:15 PM	27	310	61	1	28	39	17	0	22	210	33	0	20	49	34	0	840
05:30 PM	16	314	53	0	27	31	25	0	23	213	19	0	21	37	34	0	805
05:45 PM	23	235	52	0	37	29	21	0	23	170	17	0	16	32	32	0	687
Total	87	1201	241	1	123	122	83	0	89	801	86	0	93	145	156	1	3229
Grand Total	188	2354	519	4	232	243	164	3	155	1723	169	1	206	289	324	3	6577
Approach %	6.1	76.8	16.9	0.1	36.1	37.9	25.5	0.5	7.6	84.1	8.3	0	25.1	35.2	39.4	0.4	
Total %	2.9	35.8	7.9	0.1	3.5	3.7	2.5	0	2.4	26.2	2.6	0	3.1	4.4	4.9	0	
Unshifted	188	2354	519	4	232	243	164	3	155	1723	169	1	206	289	324	3	6577
% Unshifted	100	100	100	100	100	100	100	100	100	100	100	100	100	100	100	100	100
% Bank 1	0	0	0	0	0	0	0	0	0	0	0	0	0	0	0	0	0
% Bank 2	0	0	0	0	0	0	0	0	0	0	0	0	0	0	0	0	0
% Bank 2	0	0	0	0	0	0	0	0	0	0	0	0	0	0	0	0	0

Start Time	UNION RD Southbound			CENTER RD Westbound			UNION RD Northbound			CENTER RD Eastbound			Int. Total							
	Right	Thru	Left	Right	Thru	Left	Right	Thru	Left	Right	Thru	Left								
Peak Hour Analysis From 04:00 PM to 05:45 PM - Peak 1 of 1																				
04:45 PM																				
04:45 PM	24	324	76	0	424	18	33	22	0	73	19	249	23	0	291	24	28	41	0	93
05:00 PM	21	362	75	0	448	31	20	20	0	71	21	208	17	0	246	30	28	53	1	112
05:15 PM	27	300	61	1	389	28	39	17	0	84	22	210	33	0	265	20	48	34	0	102
05:30 PM	16	314	53	0	383	27	34	25	0	86	23	213	19	0	255	27	37	37	0	101
Total Volume	88	1290	285	1	1644	104	126	84	0	314	85	880	92	0	1057	101	141	165	1	408
% App. Total	3.4	78.5	16.1	0.1	53.1	40.1	26.8	0	0	83.3	8.7	0	24.8	94.6	40.4	0.2				
Unshifted	88	1290	285	1	1644	104	126	84	0	314	85	880	92	0	1057	101	141	165	1	408
% Unshifted	100	100	100	100	100	100	100	100	100	100	100	100	100	100	100	100	100	100	100	100
% Bank 1	0	0	0	0	0	0	0	0	0	0	0	0	0	0	0	0	0	0	0	0
% Bank 2	0	0	0	0	0	0	0	0	0	0	0	0	0	0	0	0	0	0	0	0
% Bank 2	0	0	0	0	0	0	0	0	0	0	0	0	0	0	0	0	0	0	0	0

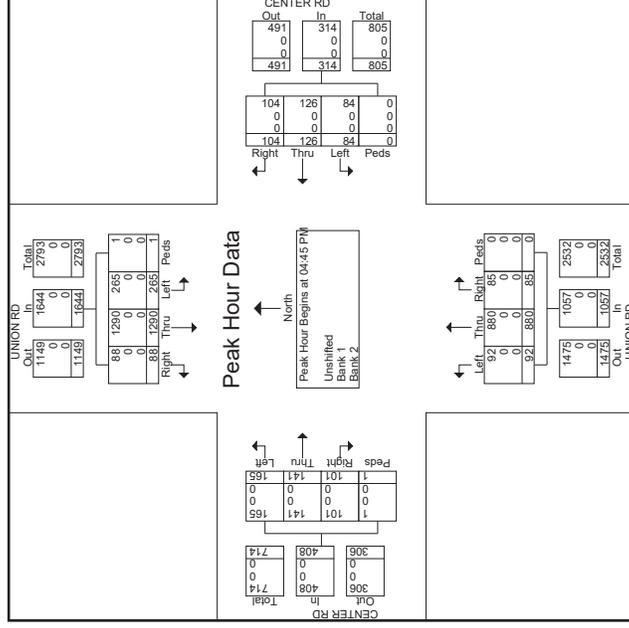

Start Time	Union Road Southbound			Norwood Drive Westbound			Union Road Northbound			Legion Parkway Eastbound			Int. Total			
	Right	Thru	Left	Right	Thru	Left	Right	Thru	Left	Right	Thru	Left				
04:00 PM	11	323	4	2	0	4	0	1	254	7	0	1	0	7	0	614
04:15 PM	10	319	5	0	0	0	0	5	254	0	0	8	0	4	0	608
04:30 PM	8	380	4	0	1	3	0	4	311	5	0	3	0	1	0	700
04:45 PM	7	364	9	0	3	0	0	5	260	1	0	3	0	2	0	656
Total	36	1386	22	0	9	0	0	15	1079	13	0	15	0	14	0	2578
05:00 PM	7	400	6	0	0	3	0	4	237	5	0	4	0	7	0	681
05:15 PM	5	356	4	0	3	0	0	6	270	3	0	3	0	6	0	667
05:30 PM	4	329	4	0	1	0	0	4	251	7	0	3	0	2	0	607
05:45 PM	7	310	4	0	3	0	0	6	235	3	0	3	0	2	0	575
Total	23	1395	18	0	15	0	0	23	983	18	0	13	0	17	0	2523
06:00 PM	14	288	9	0	8	0	0	4	216	3	0	5	0	3	0	551
Grand Total	73	3049	49	0	32	0	0	42	2288	34	0	33	0	34	0	5652
Approach %	2.3	96.2	1.5	0	64	0	0	1.8	96.8	1.4	0	49.3	0	50.7	0	
Total %	1.3	53.9	0.9	0	0.6	0	0	0.7	40.5	0.6	0	0.6	0	0.6	0	
Unshifted	73	3049	49	0	32	0	0	42	2288	34	0	33	0	34	0	5652
% Unshifted	100	100	100	0	100	0	0	100	100	100	0	100	0	100	0	100
Bank 1	0	0	0	0	0	0	0	0	0	0	0	0	0	0	0	0
Bank 2	0	0	0	0	0	0	0	0	0	0	0	0	0	0	0	0
% Bank 1	0	0	0	0	0	0	0	0	0	0	0	0	0	0	0	0
% Bank 2	0	0	0	0	0	0	0	0	0	0	0	0	0	0	0	0

Start Time	Union Road Southbound			Norwood Drive Westbound			Union Road Northbound			Legion Parkway Eastbound			Int. Total							
	Right	Thru	Left	Right	Thru	Left	Right	Thru	Left	Right	Thru	Left								
04:45 PM	7	364	9	0	380	3	0	2	0	5	260	1	0	266	3	0	2	0	5	656
05:00 PM	7	400	6	0	413	8	0	1	0	4	237	5	0	246	4	0	7	0	11	681
05:15 PM	5	356	4	0	365	3	0	1	0	4	270	3	0	282	3	0	6	0	9	667
05:30 PM	4	329	4	0	337	1	0	2	0	3	251	7	0	262	3	0	2	0	5	607
Total Volume	23	1449	23	0	1495	15	0	23	22	1018	16	0	1056	13	0	17	0	30	30	2604
% App. Total	1.5	95.9	1.5	0	63.2	0	0	34.8	0	2.1	96.4	1.5	0	43.3	0	56.7	0	0	0	882
% Unshifted	82.3	1446	639	0	905	469	0	367	0	353	611	1013	371	300	336	813	0	300	300	682
Bank 1	100	100	100	0	100	100	0	100	100	100	100	0	100	100	0	100	0	100	0	100
Bank 2	0	0	0	0	0	0	0	0	0	0	0	0	0	0	0	0	0	0	0	0
% Bank 1	100	100	100	0	100	100	0	100	100	100	100	0	100	100	0	100	0	100	0	100
% Bank 2	0	0	0	0	0	0	0	0	0	0	0	0	0	0	0	0	0	0	0	0

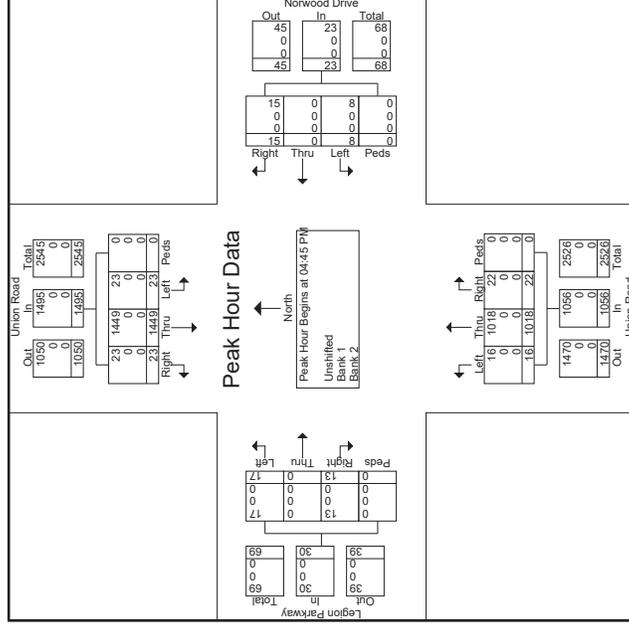

Start Time	Union Road Southbound			Seneca Street Westbound			Union Road Northbound			Seneca Street Eastbound			Int. Total				
	Right	Thru	Left	Right	Thru	Left	Right	Thru	Left	Right	Thru	Left					
04:00 PM	48	244	35	0	16	41	35	0	26	167	27	0	26	51	53	0	769
04:15 PM	31	212	31	0	22	78	53	0	32	164	30	0	18	79	58	0	808
04:30 PM	41	268	30	0	18	39	37	0	40	200	33	0	33	63	66	0	868
04:45 PM	31	263	41	0	14	49	45	0	34	195	29	0	33	89	66	0	889
Total	151	987	137	0	70	207	170	0	132	726	119	0	110	282	243	0	3334
05:00 PM	33	334	34	0	13	54	44	0	30	179	27	0	33	44	52	0	877
05:15 PM	33	268	32	0	9	46	57	0	19	163	20	0	29	41	56	0	816
05:30 PM	36	297	32	0	13	48	27	0	20	167	20	0	30	54	66	0	820
05:45 PM	58	248	23	0	14	44	41	0	26	157	18	0	21	55	67	0	775
Total	170	1147	123	0	51	192	162	0	105	686	86	0	113	200	243	0	3288
Grand Total Approach %	321	2134	260	0	121	399	332	0	237	1422	205	0	223	482	486	0	6622
Total %	11.8	78.6	9.6	0	14.2	46.8	3.9	0	12.7	76.3	1.1	0	18.7	40.5	40.8	0	6622
Unshifted	321	2134	260	0	121	399	332	0	237	1422	205	0	223	482	486	0	6622
% Unshifted	100	100	100	0	100	100	100	0	100	100	100	0	100	100	100	0	100
Bank 1	0	0	0	0	0	0	0	0	0	0	0	0	0	0	0	0	0
Bank 2	0	0	0	0	0	0	0	0	0	0	0	0	0	0	0	0	0
Bank 2	0	0	0	0	0	0	0	0	0	0	0	0	0	0	0	0	0

Start Time	Union Road Southbound			Seneca Street Westbound			Union Road Northbound			Seneca Street Eastbound			Int. Total									
	Right	Thru	Left	Right	Thru	Left	Right	Thru	Left	Right	Thru	Left										
04:45 PM	31	263	41	0	335	14	49	45	0	108	34	195	29	0	258	33	89	66	0	188	889	
05:00 PM	33	334	34	0	401	13	54	44	0	111	30	179	27	0	236	33	44	52	0	129	877	
05:15 PM	43	268	32	0	343	9	48	50	0	107	19	193	20	0	232	29	47	58	0	134	816	
05:30 PM	36	297	32	0	365	15	46	27	0	88	30	167	20	0	217	30	54	66	0	150	820	
Total Volume	143	1162	139	0	1444	51	197	166	0	414	113	734	96	0	943	125	234	282	0	601	3402	
% App. Total	9.9	80.5	9.6	0	12.3	47.6	40.1	0	12.3	47.6	40.2	0	20.8	36.9	40.3	0	20.8	36.9	40.3	0	799	957
Unshifted	143	1162	139	0	1444	51	197	166	0	414	113	734	96	0	914	125	234	282	0	799	957	
Bank 1	0	0	0	0	0	0	0	0	0	0	0	0	0	0	0	0	0	0	0	0	100	100
Bank 2	0	0	0	0	0	0	0	0	0	0	0	0	0	0	0	0	0	0	0	0	0	0
Bank 2	0	0	0	0	0	0	0	0	0	0	0	0	0	0	0	0	0	0	0	0	0	0

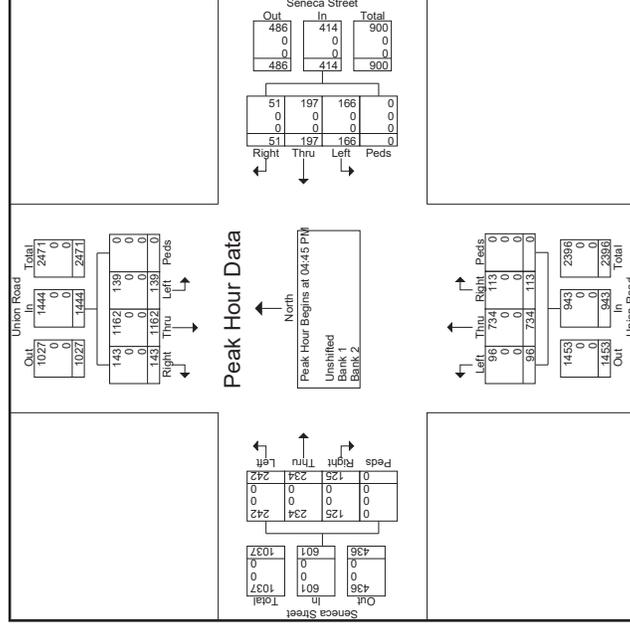

Start Time	Union Road Southbound			Willowdale Drive Westbound			Union Road Northbound			Southgate Plaza Southerly Dwy Eastbound			Int. Total			
	Right	Thru	Left	Right	Thru	Left	Right	Thru	Left	Right	Thru	Left				
04:00 PM	5	231	1	0	0	0	0	111	30	0	39	7	26	0	461	
04:15 PM	8	262	2	0	4	12	0	156	26	0	31	2	29	0	539	
04:30 PM	6	271	0	0	1	3	4	177	46	0	38	3	23	0	576	
04:45 PM	4	291	0	0	2	1	4	208	31	0	30	7	26	1	607	
Total	23	1055	3	0	7	11	23	552	133	0	138	19	104	1	2183	
05:00 PM	6	314	4	0	0	7	8	177	36	0	32	6	25	2	619	
05:15 PM	7	286	1	0	2	5	0	175	43	0	36	8	27	0	597	
05:30 PM	7	268	2	0	0	3	5	153	25	0	45	5	16	0	540	
05:45 PM	0	269	3	0	0	0	0	14	139	22	0	48	3	23	540	
Total	31	1122	10	0	2	12	21	644	137	0	161	22	91	2	2275	
Grand Total	54	2177	13	0	9	23	44	133	296	270	0	299	41	195	3	4458
Approach %	2.4	97	0.6	0	11.7	29.9	57.1	1.3	21	81.1	16.9	0	55.6	7.6	36.2	0.6
Total %	1.2	48.8	0.3	0	0.2	0.5	1	0	0.7	29.1	6.1	0	6.7	0.9	4.4	0.1
Unshifted	54	2177	13	0	9	23	44	133	296	270	0	299	41	195	3	4458
% Unshifted	100	100	100	0	100	100	100	100	100	100	0	100	100	100	100	100
Bank 1	0	0	0	0	0	0	0	0	0	0	0	0	0	0	0	0
Bank 2	0	0	0	0	0	0	0	0	0	0	0	0	0	0	0	0
Bank 2	0	0	0	0	0	0	0	0	0	0	0	0	0	0	0	0

Start Time	Union Road Southbound			Willowdale Drive Westbound			Union Road Northbound			Southgate Plaza Southerly Dwy Eastbound			Int. Total			
	Right	Thru	Left	Right	Thru	Left	Right	Thru	Left	Right	Thru	Left				
04:00 PM	5	231	1	0	0	0	0	111	30	0	39	7	26	0	461	
04:15 PM	8	262	2	0	4	12	0	156	26	0	31	2	29	0	539	
04:30 PM	6	271	0	0	1	3	4	177	46	0	38	3	23	0	576	
04:45 PM	4	291	0	0	2	1	4	208	31	0	30	7	26	1	607	
Total	23	1055	3	0	7	11	23	552	133	0	138	19	104	1	2183	
05:00 PM	6	314	4	0	0	7	8	177	36	0	32	6	25	2	619	
05:15 PM	7	286	1	0	2	5	0	175	43	0	36	8	27	0	597	
05:30 PM	7	268	2	0	0	3	5	153	25	0	45	5	16	0	540	
05:45 PM	0	269	3	0	0	0	0	14	139	22	0	48	3	23	540	
Total	31	1122	10	0	2	12	21	644	137	0	161	22	91	2	2275	
Grand Total	54	2177	13	0	9	23	44	133	296	270	0	299	41	195	3	4458
Approach %	2.4	97	0.6	0	11.7	29.9	57.1	1.3	21	81.1	16.9	0	55.6	7.6	36.2	0.6
Total %	1.2	48.8	0.3	0	0.2	0.5	1	0	0.7	29.1	6.1	0	6.7	0.9	4.4	0.1
Unshifted	54	2177	13	0	9	23	44	133	296	270	0	299	41	195	3	4458
% Unshifted	100	100	100	0	100	100	100	100	100	100	0	100	100	100	100	100
Bank 1	0	0	0	0	0	0	0	0	0	0	0	0	0	0	0	0
Bank 2	0	0	0	0	0	0	0	0	0	0	0	0	0	0	0	0
Bank 2	0	0	0	0	0	0	0	0	0	0	0	0	0	0	0	0

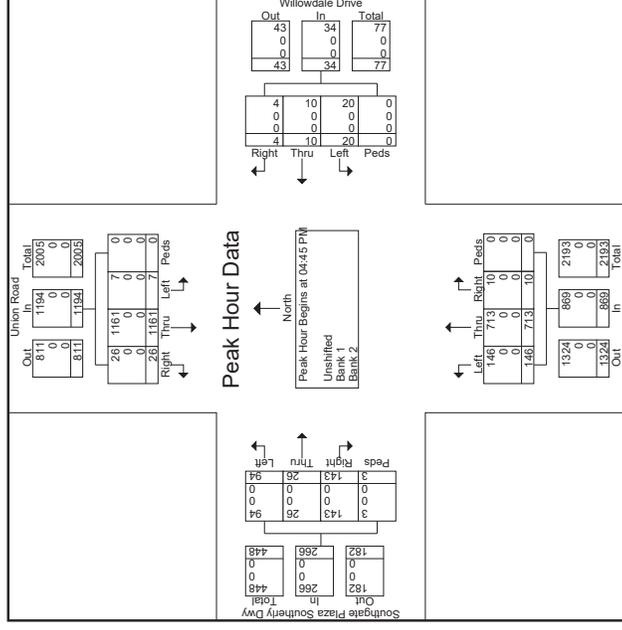

A2

**Miscellaneous Traffic Data
and Calculations**

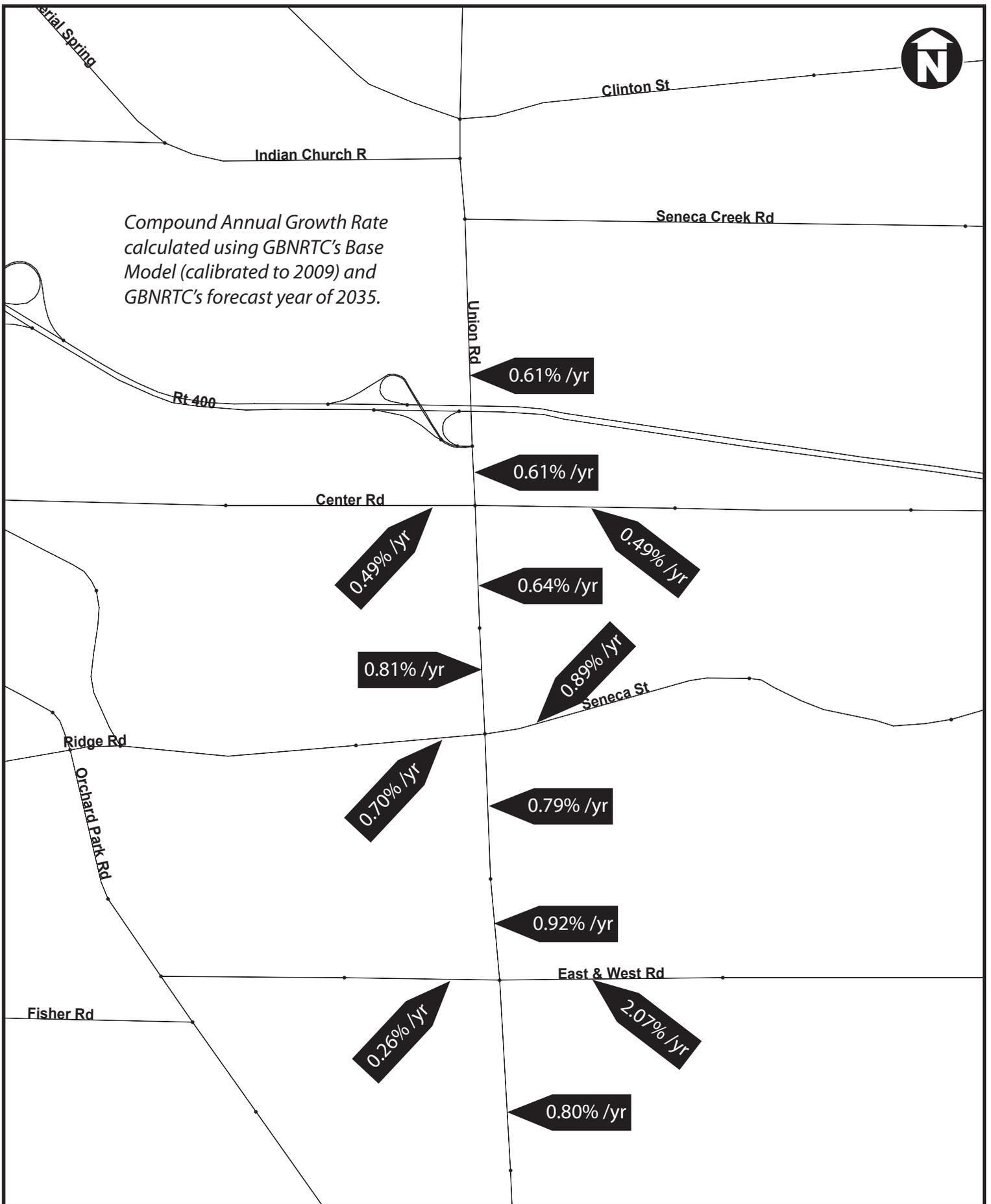

PROJECT: Union Road, Rt 400 - Cazenovia Creek
 Compound Annual Growth Rates
 SOURCE: GBNRTC Regional Travel Demand Model
 DATE: October 2016





PROJECT: Union Road, Rt 400 - Cazenovia Creek
 Select Link Analysis between Center Rd and Seneca St (showing ADT volumes that pass through selection, by direction)
 SOURCE: GBNRTC Regional Travel Demand Model
 DATE: October 2016





PROJECT: Union Road, Rt 400 - Cazenovia Creek
 Select Link Analysis | Percentage of Daily Modeled Trips Which Pass Through Entire Corridor (All Links)
 SOURCE: GBNRTC Regional Travel Demand Model
 DATE: October 2016



**UNION ROAD (NYS 277) CORRIDOR STUDY
TOWN OF WEST SENECA, ERIE COUNTY, NY
PM PEAK HOUR**

Num of yrs
10

LOCATION NUMBER	INTERSECTION DESCRIPTION	2016	2026
		Existing Volumes	Design Vol. 0.695%
1	Union Road/ I-400 Ramps		393
	SR	367	393
	ST	1059	1135
	SL		
	WR		
	WT		
	WL		
	NR	793	850
	NT	361	387
	NL		
2	Union Road/ Center Road		
	SR	88	94
	ST	1290	1383
	SL	265	284
	WR	104	111
	WT	126	135
	WL	84	90
	NR	85	91
	NT	880	943
	NL	92	99
3	Union Road/ Norwood Drive		
	SR		
	ST	1449	1553
	SL	23	25
	WR	15	16
	WT		
	WL	8	9
	NR	22	24
	NT	1013	1086
	NL		
4	Union Road/ Legion Parkway		
	SR	23	25
	ST	1434	1537
	SL		
	WR		
	WT		
	WL		
	NR		
	NT	1018	1091
	NL	16	17
5	Union Road/ Main Street		
	SR	54	58
	ST	1265	1356
	SL	138	148
	WR	41	44
	WT	54	58
	WL	28	30
	NR	26	28
	NT	922	988
	NL	80	86
6	Union Road/ Seneca Street		
	SR	143	153
	ST	1162	1245
	SL	139	149
	WR	51	55
	WT	197	211
	WL	166	178
	NR	113	121
	NT	734	787
	NL	96	103
7	Union Road/ Southgate Plaza/Willdowdale Drive		
	SR	26	28
	ST	1161	1244
	SL	7	8
	WR	4	4
	WT	10	11
	WL	20	21
	NR	10	11
	NT	713	764
	NL	146	156
	ER	143	153
	ET	26	28
	EL	94	101

New York State Department of Transportation
Classification Count Average Weekday Data Report

ROUTE #: NY 277 ROAD NAME:
 COUNTY NAME: Erie
 REGION CODE: 5
 FROM: RT 16 CENTER RD
 TO: JCT RT 400 AURORA EXPY
 REF-MARKER: 277 53011118
 END MILEPOINT: 1190 NO. OF LANES: 4
 FUNC-CLASS: 14 HPMS NO:
 STATION NO: 0011 LION#:
 COUNT TAKEN BY: ORG CODE: TTG INITIALS: DKS
 PROCESSED BY: ORG CODE: DOT INITIALS: SJW

YEAR: 2015
 MONTH: May

STATION: 530011

DIRECTION	North	South	TOTAL
NUMBER OF VEHICLES	15649	18261	33910
NUMBER OF AXLES	31492	36749	68242
% HEAVY VEHICLES (F4-F13)	2.98%	2.88%	2.93%
% TRUCKS AND BUSES (F3-F13)	15.74%	13.98%	14.79%
AXLE CORRECTION FACTOR	0.99	0.99	0.99

BATCH ID: DOT-SJWR5Cww19a Class

VEHICLE CLASS	F1	F2	F3	F4	F5	F6	F7	F8	F9	F10	F11	F12	F13	TOTAL
NO. OF AXLES	2	2	2	2.5	2	3	4	3.5	5	6	5	6	8.75	
ENDING HOUR	1:00	2	88	15	1	0	0	0	0	0	0	0	0	107
	2:00	0	47	8	1	0	0	0	0	0	0	0	0	56
	3:00	0	28	6	0	1	0	0	0	0	0	0	0	35
	4:00	1	29	10	0	1	0	0	1	1	0	0	0	43
	5:00	0	43	13	0	1	0	0	0	2	0	0	0	59
	6:00	1	124	53	0	3	1	0	0	0	0	0	0	182
	7:00	4	384	103	1	7	2	0	0	0	0	0	0	501
	8:00	3	782	140	6	16	2	0	1	1	0	0	0	951
	9:00	4	976	137	8	30	4	3	1	0	0	0	0	1163
	10:00	4	735	131	11	22	2	1	3	0	0	0	0	909
DIRECTION	11:00	7	664	125	4	21	5	0	2	1	0	0	0	829
North	12:00	6	722	118	4	20	6	2	3	1	0	0	0	862
	13:00	7	809	125	3	25	8	0	2	1	0	0	0	980
	14:00	4	824	124	4	19	3	1	4	2	0	0	0	985
	15:00	7	860	135	12	19	4	1	2	2	0	0	0	1042
	16:00	5	869	145	7	23	3	1	2	1	0	0	0	1056
	17:00	5	902	126	14	18	3	0	3	0	0	0	0	1071
	18:00	7	893	109	3	14	2	1	2	0	0	0	0	1031
	19:00	7	844	98	2	12	2	1	2	0	0	0	0	968
	20:00	6	766	89	3	8	1	0	1	0	0	0	0	874
	21:00	5	646	73	0	7	0	0	0	0	0	0	0	731
	22:00	2	557	58	0	6	1	0	0	0	0	0	0	624
	23:00	3	326	37	1	3	0	0	0	0	0	0	0	370
	24:00	0	178	18	0	3	1	0	0	0	0	0	0	200
TOTAL VEHICLES	90	13096	1996	85	280	50	11	29	12	0	0	0	0	15649
TOTAL AXLES	180	26192	3992	212	560	150	44	102	60	0	0	0	0	31492
ENDING HOUR	1:00	1	158	22	0	1	0	0	0	0	0	0	0	182
	2:00	1	70	14	0	1	0	0	0	0	0	0	0	86
	3:00	0	34	4	0	1	1	0	0	0	0	0	0	40
	4:00	0	29	3	0	1	0	0	0	1	0	0	0	34
	5:00	0	29	6	1	1	2	0	0	1	0	0	0	40
	6:00	1	87	13	2	1	1	0	0	1	0	0	0	106
	7:00	1	192	39	7	10	4	0	2	2	0	0	0	257
	8:00	2	665	102	18	24	4	1	4	1	0	0	0	821
	9:00	3	836	131	10	30	3	2	4	2	0	0	0	1021
	10:00	5	776	130	6	28	2	1	3	2	0	0	0	953
	11:00	3	759	117	3	20	4	0	3	0	1	0	0	910
DIRECTION	12:00	5	802	116	4	22	2	0	4	1	0	0	0	956
South	13:00	6	889	134	4	28	3	0	2	1	0	0	1	1068
	14:00	6	903	130	26	23	3	1	3	1	1	0	0	1097
	15:00	6	992	141	11	21	2	0	3	2	0	0	0	1178
	16:00	7	1181	161	7	24	2	0	0	0	0	0	0	1382
	17:00	9	1458	188	9	23	0	1	2	1	1	0	0	1692
	18:00	12	1674	149	2	14	2	1	0	0	0	0	0	1854
	19:00	7	1342	136	0	16	1	0	1	1	0	0	0	1504
	20:00	7	924	98	2	8	0	0	2	0	0	0	0	1041
	21:00	2	687	78	1	7	0	0	1	0	0	0	0	776
	22:00	3	528	51	0	6	0	0	0	0	0	0	0	588
	23:00	2	358	38	0	3	0	0	0	0	0	0	0	401
	24:00	2	244	26	0	2	0	0	0	0	0	0	0	274
TOTAL VEHICLES	91	15617	2027	113	315	36	7	34	17	3	0	0	1	18261
TOTAL AXLES	182	31234	4054	282	630	108	28	119	85	18	0	0	9	36749
GRAND TOTAL VEHICLES	181	28713	4023	198	595	86	18	63	29	3	0	0	1	33910
GRAND TOTAL AXLES	362	57426	8046	495	1190	258	72	220	145	18	0	0	9	68241

VEHICLE CLASSIFICATION CODES:

- F1. Motorcycles
- F2. Autos*
- F3. 2 Axle, 4-Tire Pickups, Vans, Motorhomes*
- F4. Buses
- F5. 2 Axle, 6-Tire Single Unit Trucks
- F6. 3 Axle Single Unit Trucks
- F7. 4 or More Axle Single Unit Trucks
- F8. 4 or Less Axle Vehicles, One Unit is a Truck
- F9. 5 Axle Double Unit Vehicles, One Unit is a Truck
- F10. 6 or More Double Unit Vehicles, One Unit is a Truck
- F11. 5 or Less Axle Multi-Unit Trucks
- F12. 6 Axle Multi-Unit Trucks
- F13. 7 or More Axle Multi-Unit Trucks

* INCLUDING THOSE HAULING TRAILERS

FUNCTIONAL CLASS CODES:

- | RURAL | URBAN | SYSTEM |
|-------|-------|-------------------------------|
| 01 | 11 | PRINCIPAL ARTERIAL-INTERSTATE |
| 02 | 12 | PRINCIPAL ARTERIAL-EXPRESSWAY |
| 02 | 14 | PRINCIPAL ARTERIAL-OTHER |
| 06 | 16 | MINOR ARTERIAL |
| 07 | 17 | MAJOR COLLECTOR |
| 08 | 17 | MINOR COLLECTOR |
| 09 | 19 | LOCAL SYSTEM |

TRAFFIC FLOW BY DIRECTION

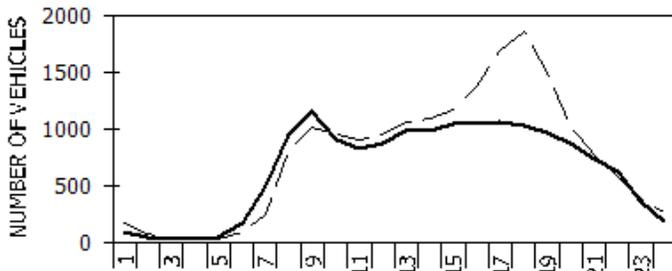

ENDING HOUR

--- North

--South

PEAK HOUR DATA

DIRECTION	HOUR	COUNT	2-WAY	HOUR	COUNT
North	9	1163	A.M.	9	2184
South	18	1854	P.M.	18	2885

SOURCE: NYSDOT DATA SERVICES BUREAU

New York State Department of Transportation
Classification Count Average Weekday Data Report

ROUTE #: NY 277 ROAD NAME:
 COUNTY NAME: Erie
 REGION CODE: 5
 FROM: CR 215 SENECA ST
 TO: RT 16 CENTER RD
 REF-MARKER:
 END MILEPOINT: 1163 NO. OF LANES: 4
 FUNC-CLASS: 14 HPMS NO: 3006244
 STATION NO: 0091 LION#:
 COUNT TAKEN BY: ORG CODE: TTG INITIALS: DKS
 PROCESSED BY: ORG CODE: DOT INITIALS: SJW

YEAR: 2015
 MONTH: May

STATION: 530091

DIRECTION	North	South	TOTAL
NUMBER OF VEHICLES	15867	16050	31917
NUMBER OF AXLES	31905	32309	64215
% HEAVY VEHICLES (F4-F13)	2.74%	2.97%	2.85%
% TRUCKS AND BUSES (F3-F13)	15.09%	15.00%	15.05%
AXLE CORRECTION FACTOR	0.99	0.99	0.99

BATCH ID: DOT-SJWR5Cww19a Class

VEHICLE CLASS	F1	F2	F3	F4	F5	F6	F7	F8	F9	F10	F11	F12	F13	TOTAL
NO. OF AXLES	2	2	2	2.5	2	3	4	3.5	5	6	5	6	8.75	
ENDING HOUR	1:00	2	60	9	1	1	0	0	0	0	0	0	0	73
	2:00	0	36	7	0	0	0	0	0	0	0	0	0	43
	3:00	0	25	5	0	1	0	0	0	0	0	0	0	31
	4:00	0	23	10	0	1	0	0	1	0	0	0	0	35
	5:00	1	48	18	0	2	0	0	0	1	0	0	0	70
	6:00	2	169	54	1	3	0	0	0	0	0	0	0	229
	7:00	2	556	118	3	12	2	0	1	0	0	0	0	694
	8:00	5	1106	149	8	19	2	0	2	0	0	0	0	1291
	9:00	2	922	124	10	22	2	2	2	1	0	0	0	1087
	10:00	3	678	121	8	23	2	0	4	1	0	0	0	840
DIRECTION	11:00	4	690	117	4	19	2	0	2	2	0	0	0	840
North	12:00	4	761	118	2	18	4	1	2	1	0	0	0	911
	13:00	6	837	117	4	20	3	0	3	0	0	0	0	990
	14:00	4	808	132	4	16	2	1	3	2	0	0	0	972
	15:00	4	888	134	10	19	4	1	2	1	0	0	0	1063
	16:00	4	934	138	6	23	3	0	3	1	0	0	0	1112
	17:00	6	983	130	13	15	2	0	3	0	1	0	0	1153
	18:00	4	912	113	2	16	2	0	3	0	0	0	0	1052
	19:00	6	825	98	3	12	1	0	2	0	0	0	0	947
	20:00	4	717	83	2	10	0	0	1	0	0	0	0	817
	21:00	5	628	79	0	6	2	0	0	0	0	0	0	720
	22:00	2	444	45	0	5	1	0	0	0	0	0	0	497
	23:00	1	224	25	0	3	0	0	0	0	0	0	0	253
	24:00	1	126	17	1	2	0	0	0	0	0	0	0	147
TOTAL VEHICLES	72	13400	1961	82	268	34	5	34	9	2	0	0	0	15867
TOTAL AXLES	144	26800	3922	205	536	102	20	119	45	12	0	0	0	31905
ENDING HOUR	1:00	1	96	15	0	2	1	0	0	0	0	0	0	115
	2:00	0	30	6	0	1	0	0	0	0	0	0	0	37
	3:00	0	23	5	0	0	0	0	0	1	0	0	0	29
	4:00	1	21	4	1	2	0	0	0	1	0	0	0	30
	5:00	0	31	6	1	0	2	0	0	1	0	0	0	41
	6:00	0	97	20	2	3	0	0	1	2	0	0	0	125
	7:00	1	267	54	12	8	5	0	1	1	0	0	0	349
	8:00	1	649	117	10	32	5	1	5	1	0	0	0	821
	9:00	2	694	121	6	25	4	2	3	2	1	0	0	860
	10:00	3	710	120	6	24	4	0	3	2	1	0	0	873
	11:00	6	724	115	2	20	4	0	2	0	0	0	0	873
DIRECTION	12:00	4	784	114	4	24	3	1	3	1	0	0	0	938
South	13:00	8	850	128	4	18	2	1	2	2	0	0	0	1015
	14:00	6	813	129	14	18	3	1	3	1	0	0	0	988
	15:00	5	969	154	10	24	4	0	2	1	0	0	0	1169
	16:00	6	1103	171	7	23	2	0	2	2	0	0	0	1316
	17:00	6	1302	166	4	20	0	0	1	0	0	0	0	1499
	18:00	8	1369	147	0	14	1	0	1	0	0	0	0	1540
	19:00	4	1035	114	0	11	1	0	2	0	0	0	0	1167
	20:00	4	702	84	2	6	1	0	1	0	0	0	0	800
	21:00	4	548	56	0	6	1	0	0	0	0	0	0	615
	22:00	2	386	39	0	4	1	0	0	0	0	0	0	432
	23:00	0	218	26	0	2	1	0	0	0	0	0	0	247
	24:00	1	148	21	0	1	0	0	0	0	0	0	0	171
TOTAL VEHICLES	73	13569	1932	85	288	45	6	32	18	2	0	0	0	16050
TOTAL AXLES	146	27138	3864	212	576	135	24	112	90	12	0	0	0	32309
GRAND TOTAL VEHICLES	145	26969	3893	167	556	79	11	66	27	4	0	0	0	31917
GRAND TOTAL AXLES	290	53938	7786	418	1112	237	44	231	135	24	0	0	0	64214

VEHICLE CLASSIFICATION CODES:

- F1. Motorcycles
- F2. Autos*
- F3. 2 Axle, 4-Tire Pickups, Vans, Motorhomes*
- F4. Buses
- F5. 2 Axle, 6-Tire Single Unit Trucks
- F6. 3 Axle Single Unit Trucks
- F7. 4 or More Axle Single Unit Trucks
- F8. 4 or Less Axle Vehicles, One Unit is a Truck
- F9. 5 Axle Double Unit Vehicles, One Unit is a Truck
- F10. 6 or More Double Unit Vehicles, One Unit is a Truck
- F11. 5 or Less Axle Multi-Unit Trucks
- F12. 6 Axle Multi-Unit Trucks
- F13. 7 or More Axle Multi-Unit Trucks

* INCLUDING THOSE HAULING TRAILERS

FUNCTIONAL CLASS CODES:

- | RURAL | URBAN | SYSTEM |
|-------|-------|-------------------------------|
| 01 | 11 | PRINCIPAL ARTERIAL-INTERSTATE |
| 02 | 12 | PRINCIPAL ARTERIAL-EXPRESSWAY |
| 02 | 14 | PRINCIPAL ARTERIAL-OTHER |
| 06 | 16 | MINOR ARTERIAL |
| 07 | 17 | MAJOR COLLECTOR |
| 08 | 17 | MINOR COLLECTOR |
| 09 | 19 | LOCAL SYSTEM |

TRAFFIC FLOW BY DIRECTION

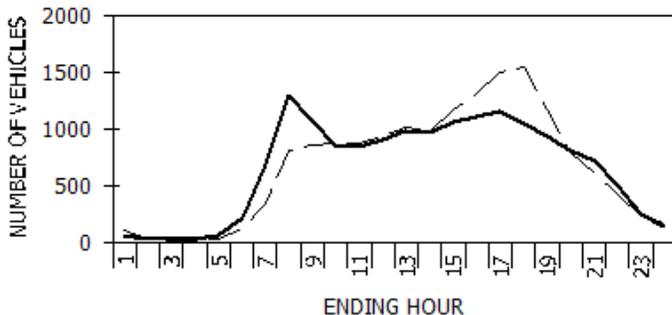

--- North --South

PEAK HOUR DATA

DIRECTION	HOUR	COUNT	2-WAY	HOUR	COUNT
North	8	1291	A.M.	8	2112
South	18	1540	P.M.	17	2652

SOURCE: NYSDOT DATA SERVICES BUREAU

Directions Printed: Combined

Start Time	Volume	2 - 3	4 - 5	6 - 7	8 - 9	10 - 11	12 - 13	14 - 15	16 - 17	18 - 19	20 - 21	22 - 23	24 - 25	26 - 27	28 - 29	>29	Int. Total	Average
4:00:00 PM	0	17	6	2	2	1	0	0	0	0	0	0	0	0	0	0	28	2 - 3
4:05:00 PM	5	22	5	1	2	0	1	0	0	0	0	0	0	0	0	0	31	2 - 3
4:10:00 PM	0	15	6	4	0	1	0	0	0	0	0	0	0	0	0	0	26	2 - 3
4:15:00 PM	0	13	4	3	4	0	0	0	0	0	0	0	0	0	0	0	24	2 - 3
4:20:00 PM	0	17	3	0	0	0	1	1	1	0	0	0	0	0	0	0	23	2 - 3
4:25:00 PM	0	16	7	0	1	0	0	0	0	0	1	0	0	0	0	0	25	2 - 3
4:30:00 PM	0	14	4	4	0	2	0	0	0	0	0	0	0	0	1	0	25	2 - 3
4:35:00 PM	0	18	4	2	3	0	0	0	0	0	0	0	0	0	0	0	27	2 - 3
Grand Total	5	132	39	16	12	4	2	1	1	0	1	0	0	0	1	0	209	2 - 3
Total %		63.2	18.7	7.7	5.7	1.9	1.0	0.5	0.5	0.0	0.5	0.0	0.0	0.0	0.5	0.0		

Directions Printed: Direction 2 - Northbound

Start Time	Volume	2 - 3	4 - 5	6 - 7	8 - 9	10 - 11	12 - 13	14 - 15	16 - 17	18 - 19	20 - 21	22 - 23	24 - 25	26 - 27	28 - 29	>29	Int. Total	Average
4:00:00 PM	0	11	4	3	3	5	0	1	1	0	0	0	0	0	0	0	28	4 - 5
4:05:00 PM	2	12	3	5	2	1	1	1	1	0	1	0	0	0	0	0	27	4 - 5
4:10:00 PM	0	13	6	6	2	2	0	0	0	0	0	0	0	0	0	0	29	4 - 5
4:15:00 PM	0	12	5	5	2	1	1	1	0	0	0	0	1	0	0	0	28	4 - 5
4:20:00 PM	0	12	6	2	2	0	0	0	1	3	0	1	0	0	0	0	27	4 - 5
4:25:00 PM	0	10	4	3	2	0	1	1	0	0	0	0	0	0	0	1	22	4 - 5
4:30:00 PM	0	10	7	1	1	3	0	2	1	0	0	0	0	0	1	0	26	4 - 5
4:35:00 PM	0	5	4	1	1	3	3	1	1	0	0	0	0	0	1	0	20	8 - 9
Grand Total	2	85	39	26	15	15	6	7	5	3	1	1	1	0	2	1	207	4 - 5
Total %		41.1	18.8	12.6	7.2	7.2	2.9	3.4	2.4	1.4	0.5	0.5	0.5	0.0	1.0	0.5		

Directions Printed: Direction 1 - Southbound

Start Time	Volume	2 - 3	4 - 5	6 - 7	8 - 9	10 - 11	12 - 13	14 - 15	16 - 17	18 - 19	20 - 21	22 - 23	24 - 25	26 - 27	28 - 29	>29	Int. Total	Average
4:00:00 PM	0	16	5	1	1	1	1	0	1	1	0	0	0	0	0	0	27	2 - 3
4:05:00 PM	3	21	7	3	2	1	1	0	0	0	0	0	0	1	0	0	36	2 - 3
4:10:00 PM	0	15	2	1	3	1	0	0	0	1	0	0	0	0	0	0	23	2 - 3
4:15:00 PM	0	8	3	2	1	1	0	0	1	0	0	0	0	0	0	1	17	4 - 5
4:20:00 PM	0	8	1	1	1	0	2	1	0	0	0	1	0	0	0	0	15	2 - 3
4:25:00 PM	0	8	4	1	1	0	3	1	1	0	0	1	0	0	0	0	20	4 - 5
4:30:00 PM	0	15	6	2	2	1	1	0	0	1	0	0	0	0	1	0	29	2 - 3
4:35:00 PM	0	16	7	3	2	1	0	0	2	0	0	1	0	0	0	0	32	4 - 5
Grand Total	3	107	35	14	13	6	8	2	5	3	0	3	0	1	1	1	199	2 - 3
Total %		53.8	17.6	7.0	6.5	3.0	4.0	1.0	2.5	1.5	0.0	1.5	0.0	0.5	0.5	0.5		

Directions Printed: Combined

Start Time	Volume	2 - 3	4 - 5	6 - 7	8 - 9	10 - 11	12 - 13	14 - 15	16 - 17	18 - 19	20 - 21	22 - 23	24 - 25	26 - 27	28 - 29	>29	Int. Total	Average
4:53:00 PM	0	10	4	0	1	1	0	0	0	0	0	1	0	0	0	0	17	2 - 3
4:58:00 PM	0	12	2	1	3	0	0	0	0	0	0	0	0	0	0	0	18	2 - 3
5:03:00 PM	0	8	3	2	0	0	0	0	0	0	0	0	0	0	0	0	13	2 - 3
5:08:00 PM	0	16	2	3	0	1	1	1	0	1	0	0	0	0	0	0	25	2 - 3
5:13:00 PM	0	13	5	0	3	1	0	0	0	0	0	0	0	0	0	0	22	2 - 3
5:18:00 PM	0	19	2	3	1	0	0	0	0	0	0	0	0	0	0	0	25	2 - 3
5:23:00 PM	0	10	2	2	0	1	1	0	1	0	0	0	0	0	0	0	17	2 - 3
5:28:00 PM	0	13	0	2	1	1	0	0	0	0	0	0	0	0	1	0	18	2 - 3
5:33:00 PM	0	9	5	3	3	0	0	0	0	0	0	0	0	0	0	0	20	4 - 5
5:38:00 PM	0	12	4	0	0	0	0	0	0	1	0	0	1	0	0	0	18	2 - 3
5:43:00 PM	0	15	3	1	3	0	0	0	0	0	0	0	0	0	0	0	22	2 - 3
Grand Total	0	137	32	17	15	5	2	1	1	2	0	1	1	0	1	0	215	2 - 3
Total %		63.7	14.9	7.9	7.0	2.3	0.9	0.5	0.5	0.9	0.0	0.5	0.5	0.0	0.5	0.0		

Directions Printed: Direction 2 - Northbound

Start Time	Volume	2 - 3	4 - 5	6 - 7	8 - 9	10 - 11	12 - 13	14 - 15	16 - 17	18 - 19	20 - 21	22 - 23	24 - 25	26 - 27	28 - 29	>29	Int. Total	Average
4:53:00 PM	0	14	5	3	1	0	0	3	0	0	0	0	0	0	0	0	26	2 - 3
4:58:00 PM	0	5	3	1	3	0	1	2	0	0	0	0	0	0	1	1	17	6 - 7
5:03:00 PM	0	8	4	3	1	1	1	1	0	0	2	0	0	0	0	0	21	4 - 5
5:08:00 PM	0	6	6	3	1	1	1	0	1	2	1	0	0	0	0	0	22	4 - 5
5:13:00 PM	0	10	7	1	1	3	1	0	1	0	1	0	0	0	0	0	25	4 - 5
5:18:00 PM	0	12	4	6	1	0	0	2	1	0	1	0	0	0	0	0	27	4 - 5
5:23:00 PM	0	12	3	0	3	4	2	1	0	0	0	0	0	0	0	0	25	4 - 5
5:28:00 PM	0	10	2	1	3	1	0	0	1	0	0	0	0	0	0	2	20	4 - 5
5:33:00 PM	0	8	6	5	3	1	2	0	0	0	1	0	0	0	0	0	26	4 - 5
5:38:00 PM	0	6	5	1	3	0	0	0	0	2	0	1	1	0	0	0	19	4 - 5
5:43:00 PM	0	12	4	0	1	0	1	0	2	0	1	0	1	0	0	0	22	2 - 3
Grand Total	0	103	49	24	21	11	9	9	6	4	7	1	2	0	1	3	250	4 - 5
Total %		41.2	19.6	9.6	8.4	4.4	3.6	3.6	2.4	1.6	2.8	0.4	0.8	0.0	0.4	1.2		

Directions Printed: Direction 1 - Southbound

Start Time	Volume	2 - 3	4 - 5	6 - 7	8 - 9	10 - 11	12 - 13	14 - 15	16 - 17	18 - 19	20 - 21	22 - 23	24 - 25	26 - 27	28 - 29	>29	Int. Total	Average
4:53:00 PM	0	9	2	3	3	0	1	1	0	0	0	0	0	0	0	0	19	4 - 5
4:58:00 PM	0	11	2	1	2	0	0	2	0	0	0	0	0	0	0	0	18	2 - 3
5:03:00 PM	0	14	4	1	0	0	0	0	0	0	0	0	0	0	0	0	19	2 - 3
5:08:00 PM	0	15	4	0	1	1	1	0	0	0	0	0	0	1	0	1	24	2 - 3
5:13:00 PM	0	12	3	0	3	2	1	0	0	0	0	1	0	0	0	0	22	2 - 3
5:18:00 PM	0	8	4	0	3	0	1	1	0	0	0	1	0	0	0	0	18	4 - 5
5:23:00 PM	0	11	1	3	1	0	0	2	0	1	1	0	0	0	0	0	20	2 - 3
5:28:00 PM	0	12	2	2	2	0	0	0	0	0	1	0	0	0	0	0	19	2 - 3
5:33:00 PM	0	13	4	1	2	0	1	0	0	0	0	1	0	1	0	0	23	2 - 3
5:38:00 PM	0	7	3	1	1	2	0	0	1	1	0	0	0	0	0	0	16	4 - 5
5:43:00 PM	0	9	7	3	1	1	1	1	0	0	0	0	0	0	0	0	23	4 - 5
Grand Total	0	121	36	15	19	6	6	7	1	2	2	3	0	2	0	1	221	2 - 3
Total %		54.8	16.3	6.8	8.6	2.7	2.7	3.2	0.5	0.9	0.9	1.4	0.0	0.9	0.0	0.5		

Class	Vehicle Count	85 Percentile	10 MPH Pace Speed	Number in Pace	Percent in Pace	Number of Vehicles Over 40 MPH	Percent of Vehicles Over 40 MPH	Average Speed	Number of Vehicles Over 40 MPH	Percent of Vehicles Over 40 MPH
Southbound	65	43	34 - 43	55	85	18	28	38	18	28
Northbound	75	44	34 - 43	60	80	22	29	40	22	29
Summary	140	43	34 - 43	115	82	40	29	39	40	29

A3

Level of Service: Criteria and Definitions

Level of Service Criteria

Highway Capacity Manual 2010

SIGNALIZED INTERSECTIONS

Level of Service is a qualitative measure describing operational conditions within a traffic stream, based on service measures such as speed and travel time, freedom to maneuver, traffic interruptions, comfort, and convenience. Level of Service for signalized intersections is defined in terms of delay specifically, average total delay per vehicle for a 15 minute analysis period. The ranges are as follows:

Level of Service	Control Delay per vehicle (seconds)
A	< 10
B	10 – 20
C	20 – 35
D	35 – 55
E	55 – 80
F	>80

UNSIGNALIZED INTERSECTIONS

Level of Service for unsignalized intersections is also defined in terms of delay. However, the delay criteria are different from a signalized intersection. The primary reason for this is driver expectation that a signalized intersection is designed to carry higher volumes than an unsignalized intersection. The total delay threshold for any given Level of Service is less for an unsignalized intersection than for a signalized intersection. The ranges are as follows:

Level of Service	Control Delay per vehicle (seconds)
A	< 10
B	10 – 15
C	15 – 25
D	25 – 35
E	35 - 50
F	>50

A4

**Level of Service Calculations:
2016 Existing Conditions**

Union Road Corridor Study
1: Union Road & NYS 400

2016 Existing Conditions - PM Peak Hour
1/16/2017

Lane Group	EBL	EBR	NBL	NBT	SBT	SBR
Lane Configurations	WV	WV	WV	WV	WV	WV
Volume (vph)	273	760	361	793	1059	367
Ideal Flow (vphpl)	1900	1900	1900	1900	1900	1900
Storage Length (ft)	0	0	75	230	230	0
Storage Lanes	2	1	1	1	1	1
Taper Length (ft)	25	80	80	80	80	80
Lane Util. Factor	0.97	0.91	0.80	0.95	0.95	1.00
Fit	0.913	0.850	0.950	0.850	0.850	0.850
Flt Protected	0.980	0.950	0.950	0.950	0.950	0.950
Satd. Flow (prot)	3082	1441	1770	3539	3539	1495
Flt Permitted	0.980	0.116	0.116	0.116	0.116	0.116
Satd. Flow (perm)	3082	1441	216	3539	3539	1495
Right Turn on Red	Yes	Yes	Yes	Yes	Yes	Yes
Satd. Flow (RTOR)	352	16	40	40	40	117
Link Speed (mph)	45	45	45	45	45	45
Link Distance (ft)	338	338	874	995	995	995
Travel Time (s)	5.1	5.1	14.9	17.0	17.0	17.0
Peak Hour Factor	0.89	0.89	0.96	0.96	0.89	0.89
Heavy Vehicles (%)	14%	2%	2%	2%	2%	8%
Adj. Flow (vph)	307	854	376	826	1190	412
Shared Lane Traffic (%)	50%	50%	50%	50%	50%	50%
Lane Group Flow (vph)	734	427	376	826	1190	412
Enter Blocked Intersection	No	No	No	No	No	No
Lane Alignment	Left	Right	Left	Left	Left	Right
Median Width(ft)	24	12	12	12	12	12
Link Offset(ft)	0	0	0	0	0	0
Crosswalk Width(ft)	16	16	16	16	16	16
Two way Left Turn Lane	Yes	Yes	Yes	Yes	Yes	Yes
Headway Factor	1.00	1.00	1.00	1.00	1.00	1.00
Turning Speed (mph)	15	9	15	15	15	9
Number of Detectors	1	1	1	2	2	1
Detector Template	Left	Right	Left	Thru	Thru	Right
Leading Detector (ft)	20	20	20	100	100	20
Trailing Detector (ft)	0	0	0	0	0	0
Detector 1 Position(ft)	0	0	0	0	0	0
Detector 1 Size(ft)	20	20	20	6	6	20
Detector 1 Type	Cl+Ex	Cl+Ex	Cl+Ex	Cl+Ex	Cl+Ex	Cl+Ex
Detector 1 Channel						
Detector 1 Extend (s)	0.0	0.0	0.0	0.0	0.0	0.0
Detector 1 Queue (s)	0.0	0.0	0.0	0.0	0.0	0.0
Detector 1 Delay (s)	0.0	0.0	0.0	0.0	0.0	0.0
Detector 2 Position(ft)	94	94	94	94	94	94
Detector 2 Size(ft)	6	6	6	6	6	6
Detector 2 Type	Cl+Ex	Cl+Ex	Cl+Ex	Cl+Ex	Cl+Ex	Cl+Ex
Detector 2 Channel						
Detector 2 Extend (s)	0.0	0.0	0.0	0.0	0.0	0.0
Turn Type	Prot	pm+ov	pm+pt	NA	NA	pm+ov
Protected Phases	3	1	1	2	2	3
Permitted Phases		3	2			2

Union Road Corridor Study
1: Union Road & NYS 400

2016 Existing Conditions - PM Peak Hour
1/16/2017

Lane Group	EBL	EBR	NBL	NBT	SBT	SBR
Detector Phase	3	1	1	2	2	3
Switch Phase						
Minimum Initial (s)	100	6.0	6.0	20.0	20.0	10.0
Minimum Split (s)	20.0	20.0	20.0	34.5	34.5	20.0
Total Split (s)	30.0	20.0	20.0	40.0	40.0	30.0
Total Split (%)	33.3%	22.2%	22.2%	44.4%	44.4%	33.3%
Maximum Green (s)	24.5	15.7	15.7	34.5	34.5	24.5
Yellow Time (s)	3.9	3.2	3.2	3.9	3.9	3.9
All-Red Time (s)	1.6	1.1	1.1	1.6	1.6	1.6
Lost Time Adjust (s)	0.0	0.0	0.0	0.0	0.0	0.0
Total Lost Time (s)	5.5	4.3	4.3	5.5	5.5	5.5
Lead/Lag	Lead	Lead	Lead	Lag	Lag	Lag
Lead-Lag Optimize?	Yes	Yes	Yes	Yes	Yes	Yes
Vehicle Extension (s)	3.5	3.5	3.5	4.0	4.0	3.5
Recall Mode	None	C-Max	C-Max	Min	Min	None
Walk Time (s)				7.0	7.0	
Flash Dont Walk (s)				22.0	22.0	
Pedestrian Calls (#/hr)				0	0	
Act Effct Green (s)	19.7	45.7	56.2	34.5	34.5	59.7
Actuated g/C Ratio	0.22	0.51	0.62	0.38	0.38	0.66
v/c Ratio	0.77	0.58	0.77	0.61	0.88	0.40
Control Delay	22.3	18.7	34.3	24.7	34.8	5.5
Queue Delay	0.0	0.0	0.0	0.0	0.0	0.0
Total Delay	22.3	18.7	34.3	24.7	34.8	5.5
LOS	C	B	C	C	C	A
Approach Delay	21.0			27.7	27.3	
Approach LOS	C			C	C	
Intersection Summary						
Area Type:	Other					
Cycle Length:	90					
Actuated Cycle Length:	90					
Offset:	70 (78%), Referenced to phase 1:NBL, Start of Green					
Natural Cycle:	75					
Control Type:	Actuated-Coordinated					
Maximum v/c Ratio:	0.88					
Intersection Signal Delay:	25.5					
Intersection Capacity Utilization:	77.8%					
Analysis Period (min):	15					
ICU Level of Service:	D					
Splits and Phases:	1: Union Road & NYS 400					
Diagram						

Union Road Corridor Study
2: Union Road & Center Road

2016 Existing Conditions - PM Peak Hour
1/16/2017

Lane Group	EBL	EBT	EBR	WBL	WBT	WBR	NBL	NBT	NBR	SBL	SBR
Lane Configurations	↔	↔	↔	↔	↔	↔	↔	↔	↔	↔	↔
Volume (vph)	165	141	101	84	126	104	92	880	85	265	1290
Ideal Flow (vphpl)	1900	1900	1900	1900	1900	1900	1900	1900	1900	1900	1900
Storage Length (ft)	140	0	90	0	100	0	170	0	170	0	0
Storage Lanes	1	0	1	0	1	0	1	0	1	0	0
Taper Length (ft)	60	95	95	1.00	0.95	1.00	0.95	0.95	1.00	1.00	0.95
Lane Util. Factor	0.937	0.937	0.932	0.932	0.932	0.932	0.987	0.987	0.987	0.987	0.990
Flt Protected	0.950	0.950	0.950	0.950	0.950	0.950	0.950	0.950	0.950	0.950	0.950
Satd. Flow (prot)	1770	3316	0	1770	3299	0	1770	3493	0	1770	3504
Flt Permitted	0.236	0.583	0.113	0.113	0.113	0.113	0.113	0.113	0.113	0.113	0.113
Satd. Flow (perm)	440	3316	0	1086	3299	0	210	3493	0	319	3504
Right Turn on Red	Yes	Yes	Yes	Yes	Yes	Yes	Yes	Yes	Yes	Yes	Yes
Satd. Flow (RTOR)	104	114	114	114	114	114	101	967	93	288	1402
Link Speed (mph)	40	40	40	40	40	40	40	40	40	40	40
Link Distance (ft)	319	325	1237	874	14.9	21.1	14.9	21.1	14.9	21.1	14.9
Travel Time (s)	5.4	5.5	5.5	5.5	5.5	5.5	5.5	5.5	5.5	5.5	5.5
Peak Hour Factor	0.91	0.91	0.91	0.91	0.91	0.91	0.91	0.91	0.91	0.91	0.92
Adj. Flow (vph)	181	155	111	92	138	114	101	967	93	288	1402
Shared Lane Traffic (%)	0	0	0	0	0	0	0	0	0	0	0
Lane Group Flow (vph)	181	266	0	92	252	0	101	1060	0	288	1498
Enter Blocked Intersection	No	No	No	No	No	No	No	No	No	No	No
Lane Alignment	Left	Left	Right	Left	Right	Left	Left	Right	Left	Left	Right
Median Width (ft)	12	12	12	12	12	12	12	12	12	12	12
Link Offset (ft)	0	0	0	0	0	0	0	0	0	0	0
Crosswalk Width (ft)	16	16	16	16	16	16	16	16	16	16	16
Two way Left Turn Lane	Yes	Yes	Yes	Yes	Yes	Yes	Yes	Yes	Yes	Yes	Yes
Headway Factor	1.00	1.00	1.00	1.00	1.00	1.00	1.00	1.00	1.00	1.00	1.00
Turning Speed (mph)	15	9	15	15	9	15	15	9	15	15	9
Number of Detectors	1	2	1	2	1	2	1	2	1	2	1
Detector Template	Left	Thru	Left	Thru	Left	Thru	Left	Thru	Left	Thru	Left
Leading Detector (ft)	20	100	20	100	20	100	20	100	20	100	20
Trailing Detector (ft)	0	0	0	0	0	0	0	0	0	0	0
Detector 1 Position (ft)	0	0	0	0	0	0	0	0	0	0	0
Detector 1 Size (ft)	20	6	20	6	20	6	20	6	20	6	20
Detector 1 Type	Ch+Ex	Ch+Ex	Ch+Ex	Ch+Ex	Ch+Ex	Ch+Ex	Ch+Ex	Ch+Ex	Ch+Ex	Ch+Ex	Ch+Ex
Detector 1 Channel	0.0	0.0	0.0	0.0	0.0	0.0	0.0	0.0	0.0	0.0	0.0
Detector 1 Extend (s)	0.0	0.0	0.0	0.0	0.0	0.0	0.0	0.0	0.0	0.0	0.0
Detector 1 Queue (s)	0.0	0.0	0.0	0.0	0.0	0.0	0.0	0.0	0.0	0.0	0.0
Detector 1 Delay (s)	0.0	0.0	0.0	0.0	0.0	0.0	0.0	0.0	0.0	0.0	0.0
Detector 2 Position (ft)	94	94	94	94	94	94	94	94	94	94	94
Detector 2 Size (ft)	6	6	6	6	6	6	6	6	6	6	6
Detector 2 Type	Ch+Ex	Ch+Ex	Ch+Ex	Ch+Ex	Ch+Ex	Ch+Ex	Ch+Ex	Ch+Ex	Ch+Ex	Ch+Ex	Ch+Ex
Detector 2 Channel	0.0	0.0	0.0	0.0	0.0	0.0	0.0	0.0	0.0	0.0	0.0
Detector 2 Extend (s)	0.0	0.0	0.0	0.0	0.0	0.0	0.0	0.0	0.0	0.0	0.0
Turn Type	pm+pt	NA	pm+pt	NA	pm+pt	NA	pm+pt	NA	pm+pt	NA	pm+pt
Protected Phases	3	8	7	4	4	5	2	1	6	6	6
Permitted Phases	8	8	4	4	4	2	2	6	6	6	6
Detector Phase	3	8	7	4	4	5	2	1	6	6	6

Union Road Corridor Study
2: Union Road & Center Road

2016 Existing Conditions - PM Peak Hour
1/16/2017

Lane Group	EBL	EBT	EBR	WBL	WBT	WBR	NBL	NBT	NBR	SBL	SBR
Switch Phase	↔	↔	↔	↔	↔	↔	↔	↔	↔	↔	↔
Minimum Initial (s)	3.0	10.0	3.0	10.0	3.0	10.0	3.0	20.0	3.0	3.0	20.0
Minimum Split (s)	8.0	35.4	8.0	35.4	8.0	35.4	8.0	27.2	8.0	8.0	27.2
Total Split (s)	27.0	41.0	19.0	33.0	16.0	78.0	22.0	84.0	22.0	22.0	84.0
Total Split (%)	16.9%	25.6%	11.9%	20.6%	10.0%	48.8%	13.8%	52.5%	13.8%	13.8%	52.5%
Maximum Green (s)	22.0	35.6	14.0	27.6	11.7	72.8	17.7	78.8	17.7	17.7	78.8
Yellow Time (s)	3.5	3.9	3.5	3.9	3.2	3.9	3.2	3.9	3.2	3.2	3.9
All-Red Time (s)	1.5	1.5	1.5	1.5	1.1	1.3	1.1	1.3	1.1	1.1	1.3
Lost Time Adjust (s)	0.0	0.0	0.0	0.0	0.0	0.0	0.0	0.0	0.0	0.0	0.0
Total Lost Time (s)	5.0	5.4	5.0	5.4	4.3	5.2	4.3	5.2	4.3	4.3	5.2
Lead/Lag	Lead	Lag	Lead	Lag	Lead	Lag	Lead	Lag	Lead	Lag	Lag
Lead-Lag Optimize?	Yes	Yes	Yes	Yes	Yes	Yes	Yes	Yes	Yes	Yes	Yes
Vehicle Extension (s)	3.0	4.0	3.0	4.0	3.0	4.0	3.0	4.0	3.0	4.0	4.0
Recall Mode	None	None	None	None	None	None	None	C-Min	None	C-Min	C
Walk Time (s)	10.0	10.0	10.0	10.0	7.0	7.0	7.0	15.0	7.0	7.0	15.0
Flash Dont Walk (s)	20.0	20.0	20.0	20.0	15.0	15.0	15.0	15.0	15.0	15.0	15.0
Pedestrian Calls (#/hr)	0	0	0	0	0	0	0	0	0	0	0
Act Effct Green (s)	36.8	19.9	25.6	13.5	9.2	85.2	113.7	98.4	113.7	98.4	98.4
Actuated g/C Ratio	0.23	0.12	0.16	0.08	0.60	0.53	0.71	0.62	0.71	0.62	0.62
v/c Ratio	0.72	0.53	0.41	0.66	0.45	0.57	0.66	0.69	0.66	0.69	0.69
Control Delay	68.1	42.7	54.2	46.6	21.2	20.2	19.6	24.5	19.6	24.5	24.5
Queue Delay	0.0	0.0	0.0	0.0	0.0	0.0	0.0	0.0	0.0	0.0	1.0
Total Delay	68.1	42.7	54.2	46.6	21.2	20.2	19.6	25.5	19.6	25.5	25.5
LOS	E	D	D	D	D	C	C	C	C	B	C
Approach Delay	52.9	D	48.6	D	20.3	C	24.5	C	24.5	C	C
Approach LOS	D	D	D	D	D	C	C	C	C	C	C

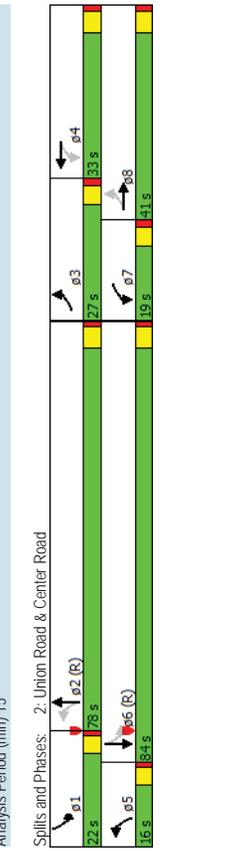

Union Road Corridor Study
3: Union Road & Nonwood Drive

2016 Existing Conditions - PM Peak Hour
1/16/2017

Intersection		0.4										
Int Delay, s/veh												
Movement	WBL	WBR	NBT	NBR	SBL	SBT						
Vol, veh/h	8	15	1013	22	23	1449						
Conflicting Peds, #/hr	0	0	0	0	0	0						
Sign Control	Stop	Stop	Free	Free	Free	Free						
RT Channelized	-	None	-	None	-	None						
Storage Length	0	-	-	-	100	-						
Veh in Median Storage, #	0	-	0	-	0	0						
Grade, %	0	-	0	-	0	0						
Peak Hour Factor	52	52	94	94	91	91						
Heavy Vehicles, %	2	2	2	2	2	2						
Mvmt Flow	15	29	1078	23	25	1592						
Major/Minor	Minor1	Major1				Major2						
Conflicting Flow All	1936	551	0	0	1101	0						
Stage 1	1089	-	-	-	-	-						
Stage 2	847	-	-	-	-	-						
Critical Hdwy	6.84	6.94	-	-	4.14	-						
Critical Hdwy Stg 1	5.84	-	-	-	-	-						
Critical Hdwy Stg 2	5.84	-	-	-	-	-						
Follow-up Hdwy	3.52	3.32	-	-	2.22	-						
Pot Cap-1 Maneuver	58	478	-	-	630	-						
Stage 1	284	-	-	-	-	-						
Stage 2	381	-	-	-	-	-						
Platoon blocked, %	-	-	-	-	-	-						
Mov Cap-1 Maneuver	56	478	-	-	630	-						
Mov Cap-2 Maneuver	171	-	-	-	-	-						
Stage 1	284	-	-	-	-	-						
Stage 2	366	-	-	-	-	-						
Approach	WB	NB				SB						
HCM Control Delay, s	19.4	0				0.2						
HCM LOS	C											
Minor Lane/Major Mvmt	NBT	NBR	WBL1	SBL	SBT							
Capacity (veh/h)	-	294	630	-	-							
HCM Lane V/C Ratio	-	0.15	0.04	-	-							
HCM Control Delay (s)	-	19.4	11	-	-							
HCM Lane LOS	-	C	B	-	-							
HCM 95th %tile Q(veh)	-	0.5	0.1	-	-							

Union Road Corridor Study
4: Union Road & Legion Parkway

2016 Existing Conditions - PM Peak Hour
1/16/2017

Intersection		0.6										
Int Delay, s/veh												
Movement	EBL	EBR	NBL	NBT	SBT	SBR						
Vol, veh/h	17	13	16	1018	1434	23						
Conflicting Peds, #/hr	0	0	0	0	0	0						
Sign Control	Stop	Stop	Free	Free	Free	Free						
RT Channelized	-	None	-	None	-	None						
Storage Length	0	-	100	-	-	-						
Veh in Median Storage, #	0	-	0	-	0	0						
Grade, %	0	-	-	0	0	-						
Peak Hour Factor	68	68	94	94	91	91						
Heavy Vehicles, %	2	2	2	2	2	2						
Mvmt Flow	25	19	17	1083	1576	25						
Major/Minor	Minor2	Major1				Major2						
Conflicting Flow All	2164	801	1601	0	-	0						
Stage 1	1588	-	-	-	-	-						
Stage 2	576	-	-	-	-	-						
Critical Hdwy	6.84	6.94	4.14	-	-	-						
Critical Hdwy Stg 1	5.84	-	-	-	-	-						
Critical Hdwy Stg 2	5.84	-	-	-	-	-						
Follow-up Hdwy	3.52	3.32	2.22	-	-	-						
Pot Cap-1 Maneuver	40	327	405	-	-	-						
Stage 1	153	-	-	-	-	-						
Stage 2	525	-	-	-	-	-						
Platoon blocked, %	-	-	-	-	-	-						
Mov Cap-1 Maneuver	38	327	405	-	-	-						
Mov Cap-2 Maneuver	119	-	-	-	-	-						
Stage 1	153	-	-	-	-	-						
Stage 2	503	-	-	-	-	-						
Approach	EB	NB				SB						
HCM Control Delay, s	34.8	0.2				0						
HCM LOS	D											
Minor Lane/Major Mvmt	NBL	NBT	EBL1	SBT	SBR							
Capacity (veh/h)	405	-	164	-	-							
HCM Lane V/C Ratio	0.042	-	0.269	-	-							
HCM Control Delay (s)	14.3	-	34.8	-	-							
HCM Lane LOS	B	-	D	-	-							
HCM 95th %tile Q(veh)	0.1	-	1	-	-							

Union Road Corridor Study
5: Union Road & Main Street

2016 Existing Conditions - PM Peak Hour
1/16/2017

Lane Group	EBL	EBT	WBL	WBT	WBR	NBL	NBT	NBR	SBL	SBR
Lane Configurations	64	62	64	28	54	41	80	922	26	138
Volume (vph)	1900	1900	1900	1900	1900	1900	1900	1900	1900	1900
Ideal Flow (vpph)	105	0	100	0	100	0	115	0	105	0
Storage Length (ft)	1	0	1	0	1	0	1	0	1	0
Storage Lanes	50	90	90	1.00	1.00	1.00	1.00	0.95	1.00	0.95
Taper Length (ft)	1.00	1.00	1.00	1.00	1.00	1.00	1.00	0.996	1.00	0.994
Lane Util. Factor	0.924		0.936							
Flt Protected	0.950		0.950		0.950		0.950		0.950	
Satd. Flow (prot)	1770	1721	0	1770	1744	0	1770	3525	0	1770
Flt Permitted	0.371		0.484		0.119		0.185		0.185	
Satd. Flow (perm)	691	1721	0	902	1744	0	222	3525	0	345
Right Turn on Red	Yes		Yes		Yes		Yes		Yes	
Satd. Flow (RTOR)	26	19	35	35	40	40	40	40	40	40
Link Speed (mph)	35	35	35	35	35	35	35	35	35	35
Link Distance (ft)	947	812	812	812	1171	1171	1171	872	872	872
Travel Time (s)	18.4	15.8	15.8	15.8	20.0	20.0	20.0	14.9	14.9	14.9
Peak Hour Factor	0.77	0.77	0.77	0.85	0.85	0.81	0.81	0.81	0.81	0.89
Adj. Flow (vph)	83	81	83	33	64	48	99	1138	32	155
Shared Lane Traffic (%)										
Lane Group Flow (vph)	83	164	0	33	112	0	99	1170	0	155
Enter Blocked Intersection	No	No	No	No	No	No	No	No	No	No
Lane Alignment	Left	Left	Right	Left	Right	Left	Left	Right	Left	Right
Median Width (ft)	12	12	12	12	12	12	12	12	12	12
Link Offset (ft)	0	0	0	0	0	0	0	0	0	0
Crosswalk Width (ft)	16	16	16	16	16	16	16	16	16	16
Two way Left Turn Lane	Yes		Yes		Yes		Yes		Yes	
Headway Factor	1.00	1.00	1.00	1.00	1.00	1.00	1.00	1.00	1.00	1.00
Turning Speed (mph)	15	9	15	15	9	15	15	9	15	9
Number of Detectors	1	2	1	2	1	2	1	2	1	2
Detector Template	Left	Thru	Left	Thru	Left	Thru	Left	Thru	Left	Thru
Leading Detector (ft)	20	100	20	100	20	100	20	100	20	100
Trailing Detector (ft)	0	0	0	0	0	0	0	0	0	0
Detector 1 Position (ft)	0	0	0	0	0	0	0	0	0	0
Detector 1 Size (ft)	20	6	20	6	20	6	20	6	20	6
Detector 1 Type	CI+EX	CI+EX	CI+EX	CI+EX	CI+EX	CI+EX	CI+EX	CI+EX	CI+EX	CI+EX
Detector 1 Channel										
Detector 1 Extend (s)	0.0	0.0	0.0	0.0	0.0	0.0	0.0	0.0	0.0	0.0
Detector 1 Queue (s)	0.0	0.0	0.0	0.0	0.0	0.0	0.0	0.0	0.0	0.0
Detector 1 Delay (s)	0.0	0.0	0.0	0.0	0.0	0.0	0.0	0.0	0.0	0.0
Detector 2 Position (ft)	94	94	94	94	94	94	94	94	94	94
Detector 2 Size (ft)	6	6	6	6	6	6	6	6	6	6
Detector 2 Type	CI+EX	CI+EX	CI+EX	CI+EX	CI+EX	CI+EX	CI+EX	CI+EX	CI+EX	CI+EX
Detector 2 Channel										
Detector 2 Extend (s)	0.0	0.0	0.0	0.0	0.0	0.0	0.0	0.0	0.0	0.0
Turn Type	pm+pt	NA	pm+pt	NA	pm+pt	NA	pm+pt	NA	pm+pt	NA
Protected Phases	3	8	7	4	4	5	2	1	6	6
Permitted Phases	8	8	4	4	2	2	6	6	6	6
Detector Phase	3	8	7	4	4	5	2	1	6	6

Union Road Corridor Study
5: Union Road & Main Street

2016 Existing Conditions - PM Peak Hour
1/16/2017

Lane Group	EBL	EBT	WBL	WBT	WBR	NBL	NBT	NBR	SBL	SBR
Switch Phase	3.0	10.0	3.0	10.0	3.0	3.0	20.0	3.0	20.0	3.0
Minimum Initial (s)	8.0	33.5	8.0	32.3	8.0	8.0	32.4	8.0	32.4	8.0
Minimum Split (s)	15.0	25.0	15.0	25.0	15.0	10.0	110.0	10.0	110.0	10.0
Total Split (s)	9.4%	15.6%	9.4%	15.6%	6.3%	68.8%	6.3%	68.8%	6.3%	68.8%
Total Split (%)	10.4	19.7	10.4	19.7	5.1	104.6	5.1	104.6	5.1	104.6
Maximum Green (s)	3.6	3.6	3.6	3.6	3.6	3.9	3.9	3.9	3.9	3.9
Yellow Time (s)	1.0	1.7	1.0	1.7	1.0	1.0	1.5	1.0	1.5	1.0
All-Red Time (s)	0.0	0.0	0.0	0.0	0.0	0.0	0.0	0.0	0.0	0.0
Lost Time Adjust (s)	4.6	5.3	4.6	5.3	4.9	5.4	5.4	4.9	5.4	5.4
Total Lost Time (s)	Lead/Lag	Lead	Lag	Lead	Lag	Lead	Lag	Lead	Lag	Lead
Lead/Lag	Yes	Yes	Yes	Yes	Yes	Yes	Yes	Yes	Yes	Yes
Lead-Lag Optimize?	3.0	2.0	3.0	2.0	2.0	4.0	2.0	4.0	2.0	4.0
Vehicle Extension (s)	None	None	None	None	None	C-Min	C-Min	None	C-Min	None
Recall Mode	7.0	7.0	7.0	7.0	7.0	7.0	7.0	7.0	7.0	7.0
Walk Time (s)	20.0	20.0	20.0	20.0	20.0	20.0	20.0	20.0	20.0	20.0
Flash Dont Walk (s)	0	0	0	0	0	0	0	0	0	0
Pedestrian Calls (#/hr)	30.5	19.8	22.6	14.0	113.1	105.5	116.2	107.1	116.2	107.1
Act Effct Green (s)	0.19	0.12	0.14	0.09	0.71	0.66	0.73	0.67	0.73	0.67
Actuated g/C Ratio	0.40	0.69	0.19	0.66	0.44	0.50	0.47	0.63	0.47	0.63
v/c Ratio	58.3	72.3	53.0	76.7	12.9	15.8	13.1	12.9	13.1	12.9
Control Delay	0.0	0.0	0.0	0.0	0.0	0.0	0.0	0.0	0.0	0.0
Queue Delay	58.3	72.3	53.0	76.7	12.9	15.8	13.1	12.9	13.1	12.9
Total Delay	E	E	D	E	B	B	B	B	B	B
LOS	E	E	D	E	B	B	B	B	B	B
Approach Delay	67.6	71.3	15.6	12.9	12.9	12.9	12.9	12.9	12.9	12.9
Approach LOS	E	E	B	B	B	B	B	B	B	B

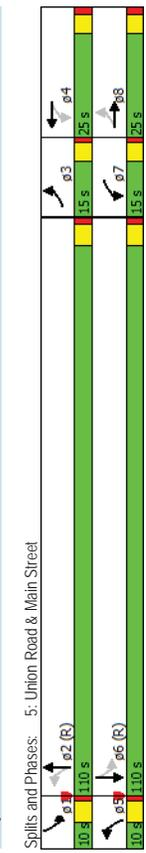

Union Road Corridor Study
6: Union Road & Seneca Street

2016 Existing Conditions - PM Peak Hour
1/16/2017

Lane Group	EBL	EBT	EBL	WBL	WBT	WBR	NBL	NBT	NBR	SBL	SBR
Lane Configurations	↔	↔	↔	↔	↔	↔	↔	↔	↔	↔	↔
Volume (vph)	242	234	125	166	197	51	96	734	113	139	1162
Ideal Flow (vphpl)	1900	1900	1900	1900	1900	1900	1900	1900	1900	1900	1900
Storage Length (ft)	175	0	115	0	130	0	160	0	160	0	0
Storage Lanes	1	0	1	0	1	0	1	0	1	0	0
Taper Length (ft)	150	0	110	0	95	0	115	0	115	0	0
Lane Util. Factor	1.00	0.95	1.00	0.95	1.00	0.95	1.00	0.95	1.00	0.95	0.95
Flt	0.948			0.969			0.980			0.984	
Flt Protected	0.950			0.950			0.950			0.950	
Satd. Flow (prot)	1770	3355	0	1770	3429	0	1770	3468	0	1770	3483
Flt Permitted	0.370			0.286			0.078			0.223	
Satd. Flow (perm)	689	3355	0	533	3429	0	145	3468	0	415	3483
Right Turn on Red		Yes		Yes			Yes		Yes		Yes
Satd. Flow (RTOR)	61			20			16			13	
Link Speed (mph)	35			35			45			40	
Link Distance (ft)	1121			353			1399			1171	
Travel Time (s)	21.8			6.9			21.2			20.0	
Peak Hour Factor	0.80	0.80	0.93	0.93	0.93	0.93	0.91	0.91	0.91	0.90	0.90
Adj. Flow (vph)	302	292	156	178	212	55	105	807	124	154	1291
Shared Lane Traffic (%)											159
Lane Group Flow (vph)	302	448	0	178	267	0	105	931	0	154	1450
Enter Blocked Intersection	No	No	No	No	No	No	No	No	No	No	No
Lane Alignment	Left	Left	Right	Left	Right	Left	Left	Right	Left	Right	Right
Median Width (ft)	12	12	12	12	12	12	12	12	12	12	12
Link Offset (ft)	0	0	0	0	0	0	0	0	0	0	0
Crosswalk Width (ft)	16			16			16			16	
Two way Left Turn Lane		Yes		Yes			Yes		Yes		Yes
Headway Factor	1.00	1.00	1.00	1.00	1.00	1.00	1.00	1.00	1.00	1.00	1.00
Turning Speed (mph)	15	9	15	15	9	15	15	9	15	15	9
Number of Detectors	1	2	1	2	1	2	1	2	1	2	2
Detector Template	Left	Thru	Left	Thru	Left	Thru	Left	Thru	Left	Thru	Thru
Leading Detector (ft)	20	100	20	100	20	100	20	100	20	100	100
Trailing Detector (ft)	0	0	0	0	0	0	0	0	0	0	0
Detector 1 Position (ft)	0	0	0	0	0	0	0	0	0	0	0
Detector 1 Size (ft)	20	6	20	6	20	6	20	6	20	6	6
Detector 1 Type	Ch+Ex	Ch+Ex	Ch+Ex	Ch+Ex	Ch+Ex	Ch+Ex	Ch+Ex	Ch+Ex	Ch+Ex	Ch+Ex	Ch+Ex
Detector 1 Channel											
Detector 1 Extend (s)	0.0	0.0	0.0	0.0	0.0	0.0	0.0	0.0	0.0	0.0	0.0
Detector 1 Queue (s)	0.0	0.0	0.0	0.0	0.0	0.0	0.0	0.0	0.0	0.0	0.0
Detector 1 Delay (s)	0.0	0.0	0.0	0.0	0.0	0.0	0.0	0.0	0.0	0.0	0.0
Detector 2 Position (ft)	94		94		94		94		94		94
Detector 2 Size (ft)	6		6		6		6		6		6
Detector 2 Type	Ch+Ex		Ch+Ex		Ch+Ex		Ch+Ex		Ch+Ex		Ch+Ex
Detector 2 Channel											
Detector 2 Extend (s)	0.0	0.0	0.0	0.0	0.0	0.0	0.0	0.0	0.0	0.0	0.0
Turn Type	pm+pt	NA	pm+pt	NA	pm+pt	NA	pm+pt	NA	pm+pt	NA	NA
Protected Phases	7	4	3	8	5	2	1	6	1	6	6
Permitted Phases	4	8	8	2	2	6	6	6	6	6	6
Detector Phase	7	4	3	8	5	2	1	6	1	6	6

Lanes, Volumes, Timings
SRF & Associates
Synchro 8 Report
Page 14

Union Road Corridor Study
6: Union Road & Seneca Street

2016 Existing Conditions - PM Peak Hour
1/16/2017

Lane Group	EBL	EBT	EBL	WBL	WBT	WBR	NBL	NBT	NBR	SBL	SBR
Switch Phase	↔	↔	↔	↔	↔	↔	↔	↔	↔	↔	↔
Minimum Initial (s)	3.0	10.0	3.0	10.0	3.0	10.0	3.0	20.0	3.0	3.0	20.0
Minimum Split (s)	8.0	32.3	8.0	32.3	8.0	32.3	8.0	28.5	8.0	8.0	28.5
Total Split (s)	20.0	30.0	20.0	30.0	20.0	30.0	20.0	70.0	20.0	20.0	70.0
Total Split (%)	14.3%	21.4%	14.3%	21.4%	14.3%	21.4%	14.3%	50.0%	14.3%	14.3%	50.0%
Maximum Green (s)	15.7	24.7	15.7	24.7	15.7	24.7	15.7	64.5	15.7	15.7	64.5
Yellow Time (s)	3.2	3.6	3.2	3.6	3.2	3.6	3.2	4.3	3.2	3.2	4.3
All-Red Time (s)	1.1	1.7	1.1	1.7	1.1	1.7	1.1	1.2	1.1	1.1	1.2
Lost Time Adjust (s)	0.0	0.0	0.0	0.0	0.0	0.0	0.0	0.0	0.0	0.0	0.0
Total Lost Time (s)	4.3	5.3	4.3	5.3	4.3	5.3	4.3	5.5	4.3	4.3	5.5
Lead/Lag	Lead	Lag	Lead	Lag	Lead	Lag	Lead	Lag	Lead	Lag	Lag
Lead-Lag Optimize?	Yes	Yes	Yes	Yes	Yes	Yes	Yes	Yes	Yes	Yes	Yes
Vehicle Extension (s)	2.0	4.0	2.0	4.0	2.0	4.0	2.0	4.0	2.0	2.0	4.0
Recall Mode	None	None	None	None	None	None	None	C-Min	None	None	C-Min
Walk Time (s)	7.0	7.0	7.0	7.0	7.0	7.0	7.0	7.0	7.0	7.0	7.0
Flash Dont Walk (s)	20.0	20.0	20.0	20.0	20.0	20.0	20.0	16.0	20.0	16.0	20.0
Pedestrian Calls (#/hr)	0		0		0		0		0		0
Act Effct Green (s)	40.3	23.7	34.6	19.8	83.5	73.6	85.2	74.4	85.2	74.4	74.4
Actuated v/c Ratio	0.29	0.17	0.25	0.14	0.60	0.53	0.61	0.53	0.61	0.53	0.53
v/c Ratio	0.90	0.72	0.70	0.53	0.56	0.51	0.45	0.78	0.45	0.78	0.78
Control Delay	72.8	54.7	52.7	54.7	26.4	23.1	15.3	30.9	15.3	30.9	30.9
Queue Delay	0.0	0.0	0.0	0.0	0.0	0.0	0.0	0.0	0.0	0.0	0.0
Total Delay	72.8	54.7	52.7	54.7	26.4	23.1	15.3	30.9	15.3	30.9	30.9
LOS	E	D	D	D	C	C	C	C	B	B	C
Approach Delay	62.0		53.9		23.5		29.4		29.4		29.4
Approach LOS	E		D		C		C		C		C

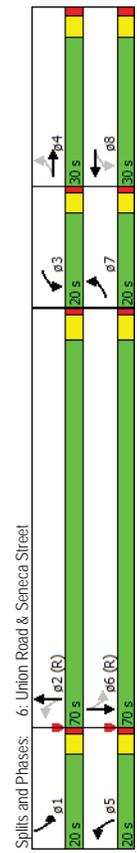

Lanes, Volumes, Timings
SRF & Associates
Synchro 8 Report
Page 15

Union Road Corridor Study
7: Union Road & Southgate Plaza/Willowdale Drive

2016 Existing Conditions - PM Peak Hour
1/16/2017

Lane Group	EBL	EBT	EBR	WBL	WBT	WBR	NBL	NBT	NBR	SBL	SBR
Lane Configurations	94	26	143	20	10	4	146	713	10	7	1161
Volume (vph)	1900	1900	1900	1900	1900	1900	1900	1900	1900	1900	1900
Ideal Flow (vpph)	65	0	0	0	0	70	0	50	0	50	0
Storage Length (ft)	1	0	0	0	0	1	0	1	0	1	0
Storage Lanes	25	0	0	25	0	25	0	100	0	100	0
Taper Length (ft)	1.00	1.00	1.00	1.00	1.00	1.00	1.00	0.95	1.00	0.95	0.95
Lane Util. Factor	0.873			0.984		0.972		0.998		0.997	
Flt Protected	0.950			0.972		0.950		0.950		0.950	
Satd. Flow (prot)	1770	1626	0	1782	0	1770	3532	0	1770	3529	0
Flt Permitted	0.815			0.506		0.126		0.291		0.291	
Satd. Flow (perm)	1518	1626	0	927	0	235	3532	0	542	3529	0
Right Turn on Red		Yes			Yes			Yes		Yes	
Satd. Flow (RTOR)	152			6		2		4		4	
Link Speed (mph)	15			30		45		45		45	
Link Distance (ft)	325			582		648		1399		1399	
Travel Time (s)	14.8			13.2		9.8		21.2		21.2	
Peak Hour Factor	0.94	0.94	0.94	0.57	0.57	0.89	0.89	0.89	0.89	0.92	0.92
Adj. Flow (vph)	100	28	152	35	18	7	164	801	11	8	1262
Shared Lane Traffic (%)											
Lane Group Flow (vph)	100	180	0	0	60	0	164	812	0	8	1290
Enter Blocked Intersection	No	No	No	No	No	No	No	No	No	No	No
Lane Alignment	Left	Left	Right	Left	Right	Left	Left	Right	Left	Right	Right
Median Width (ft)	12	12	12	12	12	12	12	12	12	12	12
Link Offset (ft)	0	0	0	0	0	0	0	0	0	0	0
Crosswalk Width (ft)	16			16		16		16		16	
Two way Left Turn Lane											Yes
Headway Factor	1.00	1.00	1.00	1.00	1.00	1.00	1.00	1.00	1.00	1.00	1.00
Turning Speed (mph)	15	9	15	15	9	15	15	9	15	15	9
Number of Detectors	1	2	1	2	1	2	1	2	1	2	1
Detector Template	Left	Thru	Left	Thru	Left	Thru	Left	Thru	Left	Thru	Left
Leading Detector (ft)	20	100	20	100	20	100	20	100	20	100	20
Trailing Detector (ft)	0	0	0	0	0	0	0	0	0	0	0
Detector 1 Position (ft)	0	0	0	0	0	0	0	0	0	0	0
Detector 1 Size (ft)	20	6	20	6	20	6	20	6	20	6	20
Detector 1 Type	Ch+Ex	Ch+Ex	Ch+Ex	Ch+Ex	Ch+Ex	Ch+Ex	Ch+Ex	Ch+Ex	Ch+Ex	Ch+Ex	Ch+Ex
Detector 1 Channel											
Detector 1 Extend (s)	0.0	0.0	0.0	0.0	0.0	0.0	0.0	0.0	0.0	0.0	0.0
Detector 1 Queue (s)	0.0	0.0	0.0	0.0	0.0	0.0	0.0	0.0	0.0	0.0	0.0
Detector 1 Delay (s)	0.0	0.0	0.0	0.0	0.0	0.0	0.0	0.0	0.0	0.0	0.0
Detector 2 Position (ft)	94			94		94		94		94	
Detector 2 Size (ft)	6			6		6		6		6	
Detector 2 Type	Ch+Ex			Ch+Ex		Ch+Ex		Ch+Ex		Ch+Ex	
Detector 2 Channel											
Detector 2 Extend (s)	0.0			0.0		0.0		0.0		0.0	
Turn Type	Perm	NA	Perm	NA	pm+pt	NA	Perm	NA	Perm	NA	NA
Protected Phases	3	3	3	3	3	3	3	3	3	3	2
Permitted Phases	3	3	3	3	3	3	3	3	3	3	2
Detector Phase	3	3	3	3	3	3	3	3	3	3	2

Lanes, Volumes, Timings
SRF & Associates
Synchro 8 Report
Page 17

Union Road Corridor Study
7: Union Road & Southgate Plaza/Willowdale Drive

2016 Existing Conditions - PM Peak Hour
1/16/2017

Lane Group	EBL	EBT	EBR	WBL	WBT	WBR	NBL	NBT	NBR	SBL	SBR
Switch Phase											
Minimum Initial (s)	6.0	6.0	6.0	6.0	6.0	6.0	3.0	20.0	20.0	20.0	20.0
Minimum Split (s)	32.3	32.3	32.3	32.3	32.3	32.3	8.0	25.5	25.5	25.5	25.5
Total Split (s)	20.0	20.0	20.0	20.0	20.0	20.0	15.0	55.0	55.0	55.0	55.0
Total Split (%)	22.2%	22.2%	22.2%	22.2%	22.2%	22.2%	16.7%	61.1%	61.1%	61.1%	61.1%
Maximum Green (s)	14.7	14.7	14.7	14.7	14.7	14.7	10.7	49.5	49.5	49.5	49.5
Yellow Time (s)	3.6	3.6	3.6	3.6	3.6	3.6	3.2	4.3	4.3	4.3	4.3
All-Red Time (s)	1.7	1.7	1.7	1.7	1.7	1.7	1.1	1.2	1.2	1.2	1.2
Lost Time Adjust (s)	0.0	0.0	0.0	0.0	0.0	0.0	0.0	0.0	0.0	0.0	0.0
Total Lost Time (s)	5.3	5.3	5.3	5.3	5.3	5.3	4.3	5.5	5.5	5.5	5.5
Lead/Lag							Lead	Lag	Lag	Lag	Lag
Lead-Lag Optimize?							Yes	Yes	Yes	Yes	Yes
Vehicle Extension (s)	3.0	3.0	3.0	3.0	3.0	3.0	2.0	4.0	4.0	4.0	4.0
Recall Mode	None	None	None	None	None	None	C-Max	Min	Min	Min	Min
Walk Time (s)	7.0	7.0	7.0	7.0	7.0	7.0					
Flash Dont Walk (s)	20.0	20.0	20.0	20.0	20.0	20.0					
Pedestrian Calls (#/hr)	0	0	0	0	0	0					
Act Effct Green (s)	11.5	11.5	11.5	11.5	11.5	11.5	64.6	48.1	48.1	48.1	48.1
Actuated g/C Ratio	0.13	0.13	0.13	0.13	0.13	0.13	0.72	0.53	0.53	0.53	0.53
v/c Ratio	0.52	0.53	0.49	0.38	0.43	0.43	0.03	0.68	0.03	0.68	0.68
Control Delay	45.4	14.8	45.9	45.9	45.9	45.9	8.7	13.2	9.7	17.3	17.3
Queue Delay	0.0	0.0	0.0	0.0	0.0	0.0	0.0	0.0	0.0	0.0	0.0
Total Delay	45.4	14.8	45.9	45.9	45.9	45.9	8.7	13.2	9.7	17.3	17.3
LOS	D	B	D	D	D	D	A	B	A	B	B
Approach Delay							25.7	45.9	12.5	17.3	17.3
Approach LOS							C	D	B	B	B
Intersection Summary	Other										
Area Type:	Other										
Cycle Length:	90										
Actuated Cycle Length:	90										
Offset:	75 (83%), Referenced to phase 1: NBL, Start of Green										
Natural Cycle:	80										
Control Type:	Actuated-Coordinated										
Maximum v/c Ratio:	0.68										
Intersection Signal Delay:	17.1										
Intersection Capacity Utilization:	72.4%										
Analysis Period (min):	15										
Spills and Phases:	7: Union Road & Southgate Plaza/Willowdale Drive										
	15 s	15 s	15 s	15 s	15 s	15 s	55 s	55 s	20 s	20 s	20 s

Lanes, Volumes, Timings
SRF & Associates
Synchro 8 Report
Page 18

A5

**Level of Service Calculations:
2026 Future Design Conditions**

Union Road Corridor Study
1: Union Road & NYS 400

2026 Design Conditions - PM Peak Hour
1/16/2017

Lane Group	EBL	EBR	NBL	NBT	SBT	SBR
Lane Configurations	WV	WV	WV	WV	WV	WV
Volume (vph)	293	815	387	850	1135	393
Ideal Flow (vph/ft)	1900	1900	1900	1900	1900	1900
Storage Length (ft)	0	0	75	0	230	0
Storage Lanes	2	1	1	1	1	1
Taper Length (ft)	25	80	80	80	80	80
Lane Util. Factor	0.97	0.91	1.00	0.95	0.95	1.00
Flt	0.913	0.850	0.950	0.850	0.850	0.850
Flt Protected	0.980	0.950	0.950	0.950	0.950	0.950
Satd. Flow (prot)	3082	1441	1770	3539	3539	1495
Flt Permitted	0.980	0.116	0.116	0.116	0.116	0.116
Satd. Flow (perm)	3082	1441	216	3539	3539	1495
Right Turn on Red	Yes	Yes	Yes	Yes	Yes	Yes
Satd. Flow (RTOR)	349	11	0	40	40	99
Link Speed (mph)	45	16	16	16	16	16
Link Distance (ft)	338	874	874	995	995	995
Travel Time (s)	5.1	14.9	14.9	17.0	17.0	17.0
Peak Hour Factor	0.89	0.89	0.96	0.96	0.89	0.89
Heavy Vehicles (%)	14%	2%	2%	2%	2%	8%
Adj. Flow (vph)	329	916	403	885	1275	442
Shared Lane Traffic (%)	50%					
Lane Group Flow (vph)	787	458	403	885	1275	442
Enter Blocked Intersection	No	No	No	No	No	No
Lane Alignment	Left	Right	Left	Left	Left	Right
Median Width(ft)	24	12	12	12	12	12
Link Offset(ft)	0	0	0	0	0	0
Crosswalk Width(ft)	16	16	16	16	16	16
Two way Left Turn Lane	Yes	Yes	Yes	Yes	Yes	Yes
Headway Factor	1.00	1.00	1.00	1.00	1.00	1.00
Turning Speed (mph)	15	9	15	9	9	9
Number of Detectors	1	1	2	2	1	1
Detector Template	Left	Right	Left	Thru	Right	Right
Leading Detector (ft)	20	20	100	100	20	20
Trailing Detector (ft)	0	0	0	0	0	0
Detector 1 Position(ft)	0	0	0	0	0	0
Detector 1 Size(ft)	20	20	20	6	6	20
Detector 1 Type	Cl+Ex	Cl+Ex	Cl+Ex	Cl+Ex	Cl+Ex	Cl+Ex
Detector 1 Channel						
Detector 1 Extend (s)	0.0	0.0	0.0	0.0	0.0	0.0
Detector 1 Queue (s)	0.0	0.0	0.0	0.0	0.0	0.0
Detector 1 Delay (s)	0.0	0.0	0.0	0.0	0.0	0.0
Detector 2 Position(ft)	94	94	94	94	94	94
Detector 2 Size(ft)	6	6	6	6	6	6
Detector 2 Type	Cl+Ex	Cl+Ex	Cl+Ex	Cl+Ex	Cl+Ex	Cl+Ex
Detector 2 Channel						
Detector 2 Extend (s)	0.0	0.0	0.0	0.0	0.0	0.0
Turn Type	Prot	pm+ov	pm+pt	NA	NA	pm+ov
Protected Phases	3	1	1	2	2	3
Permitted Phases		3	2			2

Union Road Corridor Study
1: Union Road & NYS 400

2026 Design Conditions - PM Peak Hour
1/16/2017

Lane Group	EBL	EBR	NBL	NBT	SBT	SBR
Detector Phase	3	1	1	2	2	3
Switch Phase						
Minimum Initial (s)	100	6.0	6.0	20.0	20.0	10.0
Minimum Split (s)	20.0	20.0	20.0	34.5	34.5	20.0
Total Split (s)	30.0	20.0	20.0	40.0	40.0	30.0
Total Split (%)	33.3%	22.2%	22.2%	44.4%	44.4%	33.3%
Maximum Green (s)	24.5	15.7	15.7	34.5	34.5	24.5
Yellow Time (s)	3.9	3.2	3.2	3.9	3.9	3.9
All-Red Time (s)	1.6	1.1	1.1	1.6	1.6	1.6
Lost Time Adjust (s)	0.0	0.0	0.0	0.0	0.0	0.0
Total Lost Time (s)	5.5	4.3	4.3	5.5	5.5	5.5
Lead/Lag	Lead	Lead	Lead	Lag	Lag	Lag
Lead-Lag Optimize?	Yes	Yes	Yes	Yes	Yes	Yes
Vehicle Extension (s)	3.5	3.5	3.5	4.0	4.0	3.5
Recall Mode	None	C-Max	C-Max	Min	Min	None
Walk Time (s)				7.0	7.0	
Flash Dont Walk (s)				22.0	22.0	
Pedestrian Calls (#/hr)				0	0	
Act Effct Green (s)	20.7	45.7	55.2	34.5	34.5	60.7
Actuated g/C Ratio	0.23	0.51	0.61	0.38	0.38	0.67
v/c Ratio	0.80	0.62	0.86	0.65	0.94	0.42
Control Delay	24.4	20.1	43.7	25.6	41.5	5.9
Queue Delay	0.0	0.0	0.0	0.0	0.0	0.0
Total Delay	24.4	20.1	43.7	25.6	41.5	5.9
LOS	C	C	D	C	D	A
Approach Delay	22.8			31.3	32.4	
Approach LOS	C			C	C	
Intersection Summary	Other					
Area Type:	Other					
Cycle Length: 90	Other					
Actuated Cycle Length: 90	Other					
Offset: 70 (78%), Referenced to phase 1:NBL, Start of Green	Other					
Natural Cycle: 75	Other					
Control Type: Actuated-Coordinated	Other					
Maximum v/c Ratio: 0.94	Other					
Intersection Signal Delay: 29.2	Other					
Intersection Capacity Utilization 82.5%	Other					
Analysis Period (min) 15	Other					
Intersection LOS: C	Other					
ICU Level of Service E	Other					
Splits and Phases: 1: Union Road & NYS 400	Other					
Diagram						

Union Road Corridor Study
2: Union Road & Center Road

2026 Design Conditions - PM Peak Hour
1/16/2017

Lane Group	EBL	EBT	EBR	WBL	WBT	WBR	NBL	NBT	NBR	SBL	SBR
Lane Configurations	↔	↔	↔	↔	↔	↔	↔	↔	↔	↔	↔
Volume (vph)	177	151	108	90	135	111	99	943	91	284	1383
Ideal Flow (vphpl)	1900	1900	1900	1900	1900	1900	1900	1900	1900	1900	1900
Storage Length (ft)	140	0	90	0	100	0	170	0	170	0	0
Storage Lanes	1	0	0	0	1	0	0	0	0	0	0
Taper Length (ft)	60	0	95	0	90	0	110	0	110	0	0
Lane Util. Factor	1.00	0.937	0.95	1.00	0.95	0.95	0.95	0.95	0.95	1.00	0.95
Flt Protected	0.950		0.950		0.950		0.950		0.950		0.990
Satd. Flow (prot)	1770	3316	0	1770	3299	0	1770	3493	0	1770	3504
Flt Permitted	0.219		0.564		0.089		0.129		0.129		0.129
Satd. Flow (perm)	408	3316	0	1051	3299	0	166	3493	0	240	3504
Right Turn on Red	Yes		Yes		Yes		Yes		Yes		Yes
Satd. Flow (RTOR)	104		114		114		8		8		6
Link Speed (mph)	40		40		40		40		40		40
Link Distance (ft)	319		325		1237		874		874		874
Travel Time (s)	5.4		5.5		21.1		14.9		14.9		14.9
Peak Hour Factor	0.91	0.91	0.91	0.91	0.91	0.91	0.91	0.91	0.91	0.91	0.92
Adj. Flow (vph)	195	166	119	99	148	122	109	1036	100	309	1503
Shared Lane Traffic (%)											102
Lane Group Flow (vph)	195	285	0	99	270	0	109	1136	0	309	1605
Enter Blocked Intersection	No	No	No	No	No	No	No	No	No	No	No
Lane Alignment	Left	Left	Right	Left	Right	Left	Left	Right	Left	Right	Right
Median Width (ft)	12	12	12	12	12	12	12	12	12	12	12
Link Offset (ft)	0		0		0		0		0		0
Crosswalk Width (ft)	16		16		16		16		16		16
Two way Left Turn Lane											
Headway Factor	1.00	1.00	1.00	1.00	1.00	1.00	1.00	1.00	1.00	1.00	1.00
Turning Speed (mph)	15	9	15	9	15	9	15	9	15	9	15
Number of Detectors	1	2	1	2	1	2	1	2	1	2	1
Detector Template	Left	Thru	Left	Thru	Left	Thru	Left	Thru	Left	Thru	Left
Leading Detector (ft)	20	100	20	100	20	100	20	100	20	100	20
Trailing Detector (ft)	0	0	0	0	0	0	0	0	0	0	0
Detector 1 Position (ft)	0	0	0	0	0	0	0	0	0	0	0
Detector 1 Size (ft)	20	6	20	6	20	6	20	6	20	6	20
Detector 1 Type	Ch+Ex	Ch+Ex	Ch+Ex	Ch+Ex	Ch+Ex	Ch+Ex	Ch+Ex	Ch+Ex	Ch+Ex	Ch+Ex	Ch+Ex
Detector 1 Channel											
Detector 1 Extend (s)	0.0	0.0	0.0	0.0	0.0	0.0	0.0	0.0	0.0	0.0	0.0
Detector 1 Queue (s)	0.0	0.0	0.0	0.0	0.0	0.0	0.0	0.0	0.0	0.0	0.0
Detector 1 Delay (s)	0.0	0.0	0.0	0.0	0.0	0.0	0.0	0.0	0.0	0.0	0.0
Detector 2 Position (ft)	94		94		94		94		94		94
Detector 2 Size (ft)	6		6		6		6		6		6
Detector 2 Type	Ch+Ex		Ch+Ex		Ch+Ex		Ch+Ex		Ch+Ex		Ch+Ex
Detector 2 Channel											
Detector 2 Extend (s)	0.0	0.0	0.0	0.0	0.0	0.0	0.0	0.0	0.0	0.0	0.0
Turn Type	pm+pt	NA	pm+pt	NA	pm+pt	NA	pm+pt	NA	pm+pt	NA	NA
Protected Phases	3	8	7	4	4	5	2	1	6	1	6
Permitted Phases	8	8	4	4	2	2	6	6	6	6	6
Detector Phase	3	8	7	4	4	5	2	1	6	1	6

Union Road Corridor Study
2: Union Road & Center Road

2026 Design Conditions - PM Peak Hour
1/16/2017

Lane Group	EBL	EBT	EBR	WBL	WBT	WBR	NBL	NBT	NBR	SBL	SBR
Switch Phase											
Minimum Initial (s)	3.0	10.0	3.0	10.0	3.0	10.0	3.0	20.0	3.0	20.0	3.0
Minimum Split (s)	8.0	35.4	8.0	35.4	8.0	35.4	8.0	27.2	8.0	27.2	8.0
Total Split (s)	27.0	41.0	19.0	33.0	16.0	78.0	22.0	78.0	22.0	84.0	22.0
Total Split (%)	16.9%	25.6%	11.9%	20.6%	10.0%	48.8%	13.8%	52.5%	13.8%	52.5%	13.8%
Maximum Green (s)	22.0	35.6	14.0	27.6	11.7	72.8	17.7	72.8	17.7	72.8	17.7
Yellow Time (s)	3.5	3.9	3.5	3.9	3.2	3.9	3.2	3.9	3.2	3.9	3.2
All-Red Time (s)	1.5	1.5	1.5	1.5	1.1	1.3	1.1	1.3	1.1	1.3	1.1
Lost Time Adjust (s)	0.0	0.0	0.0	0.0	0.0	0.0	0.0	0.0	0.0	0.0	0.0
Total Lost Time (s)	5.0	5.4	5.0	5.4	4.3	5.2	4.3	5.2	4.3	5.2	4.3
Lead/Lag	Lead	Lag	Lead	Lag	Lead	Lag	Lead	Lag	Lead	Lag	Lead
Lead-Lag Optimize?	Yes	Yes	Yes	Yes	Yes	Yes	Yes	Yes	Yes	Yes	Yes
Vehicle Extension (s)	3.0	4.0	3.0	4.0	3.0	4.0	3.0	4.0	3.0	4.0	3.0
Recall Mode	None	None	None	None	None	None	None	C-Min	None	C-Min	None
Walk Time (s)	10.0	10.0	10.0	10.0	7.0	7.0	7.0	15.0	7.0	15.0	7.0
Flash Dont Walk (s)	20.0	20.0	20.0	20.0	15.0	15.0	15.0	15.0	15.0	15.0	15.0
Pedestrian Calls (#/hr)	0	0	0	0	0	0	0	0	0	0	0
Act Effct Green (s)	38.5	21.2	26.7	14.3	89.9	78.1	112.1	96.0	112.1	96.0	112.1
Actuated g/C Ratio	0.24	0.13	0.17	0.09	0.56	0.49	0.70	0.60	0.70	0.60	0.70
v/c Ratio	0.76	0.54	0.43	0.68	0.54	0.67	0.70	0.76	0.70	0.76	0.76
Control Delay	69.1	43.7	53.6	48.9	30.7	25.3	31.9	28.5	31.9	28.5	31.9
Queue Delay	0.0	0.0	0.0	0.0	0.0	0.0	0.0	0.0	0.0	0.0	0.0
Total Delay	69.1	43.7	53.6	48.9	30.7	25.3	31.9	30.1	31.9	30.1	30.1
LOS	E	D	D	D	C	C	C	C	C	C	C
Approach Delay	54.0		50.2		25.8		30.4		25.8		30.4
Approach LOS	D		D		C		C		C		C

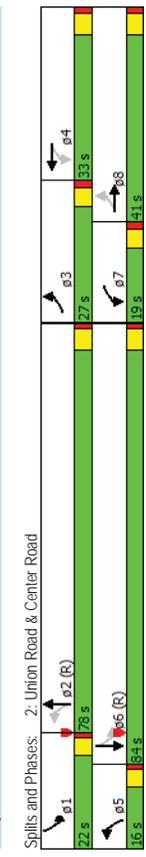

Union Road Corridor Study
3: Union Road & Nonwood Drive

2026 Design Conditions - PM Peak Hour
4: Union Road & Legion Parkway

1/16/2017

1/16/2017

Intersection		0.5									
Int Delay, s/veh											
Movement	WBL	WBR	NBT	NBR	SBL	SBT					
Vol, veh/h	9	16	1086	24	25	1553					
Conflicting Peds, #/hr	0	0	0	0	0	0					
Sign Control	Stop	Stop	Free	Free	Free	Free					
RT Channelized	-	None	-	None	-	None					
Storage Length	0	-	-	-	100	-					
Veh in Median Storage, #	0	-	0	0	-	0					
Grade, %	0	-	-	-	-	0					
Peak Hour Factor	52	52	94	94	91	91					
Heavy Vehicles, %	2	2	2	2	2	2					
Mvmt Flow	17	31	1155	26	27	1707					
Major/Minor	Minor1	Major1		Major2							
Conflicting Flow All	2076	590	0	0	1181	0					
Stage 1	1168	-	-	-	-	-					
Stage 2	908	-	-	-	-	-					
Critical Hdwy	6.84	6.94	-	-	4.14	-					
Critical Hdwy Stg 1	5.84	-	-	-	-	-					
Critical Hdwy Stg 2	5.84	-	-	-	-	-					
Follow-up Hdwy	3.52	3.32	-	-	2.22	-					
Pot Cap-1 Maneuver	46	451	-	-	587	-					
Stage 1	258	-	-	-	-	-					
Stage 2	354	-	-	-	-	-					
Platoon blocked, %	-	-	-	-	-	-					
Mov Cap-1 Maneuver	44	451	-	-	587	-					
Mov Cap-2 Maneuver	153	-	-	-	-	-					
Stage 1	258	-	-	-	-	-					
Stage 2	338	-	-	-	-	-					
Approach	WB	NB		SB							
HCM Control Delay, s	21.6	0		0.2							
HCM LOS	C										
Minor Lane/Major Mvmt	NBT	NBR	WBL1	SBL	SBT						
Capacity (veh/h)	-	265	587	-	-						
HCM Lane V/C Ratio	-	0.181	0.047	-	-						
HCM Control Delay (s)	-	21.6	11.4	-	-						
HCM Lane LOS	-	C	B	-	-						
HCM 95th %tile Q(veh)	-	0.6	0.1	-	-						

Intersection		0.7									
Int Delay, s/veh											
Movement	EBL	EBR	NBL	NBT	SBT	SBR					
Vol, veh/h	18	14	17	1091	1537	25					
Conflicting Peds, #/hr	0	0	0	0	0	0					
Sign Control	Stop	Stop	Free	Free	Free	Free					
RT Channelized	-	None	-	None	-	None					
Storage Length	0	-	100	-	-	-					
Veh in Median Storage, #	0	-	0	0	0	0					
Grade, %	0	-	-	-	0	0					
Peak Hour Factor	68	68	94	94	91	91					
Heavy Vehicles, %	2	2	2	2	2	2					
Mvmt Flow	26	21	18	1161	1689	27					
Major/Minor	Minor2	Major1		Major2							
Conflicting Flow All	2319	858	1716	0	-	0					
Stage 1	1703	-	-	-	-	-					
Stage 2	616	-	-	-	-	-					
Critical Hdwy	6.84	6.94	4.14	-	-	-					
Critical Hdwy Stg 1	5.84	-	-	-	-	-					
Critical Hdwy Stg 2	5.84	-	-	-	-	-					
Follow-up Hdwy	3.52	3.32	2.22	-	-	-					
Pot Cap-1 Maneuver	32	300	365	-	-	-					
Stage 1	133	-	-	-	-	-					
Stage 2	501	-	-	-	-	-					
Platoon blocked, %	-	-	-	-	-	-					
Mov Cap-1 Maneuver	30	300	365	-	-	-					
Mov Cap-2 Maneuver	104	-	-	-	-	-					
Stage 1	133	-	-	-	-	-					
Stage 2	476	-	-	-	-	-					
Approach	EB	NB		SB							
HCM Control Delay, s	41	0.2		0							
HCM LOS	E										
Minor Lane/Major Mvmt	NBL	NBT	EBL1	SBT	SBR						
Capacity (veh/h)	365	146	-	-	-						
HCM Lane V/C Ratio	0.05	0.322	-	-	-						
HCM Control Delay (s)	15.4	41	-	-	-						
HCM Lane LOS	C	E	-	-	-						
HCM 95th %tile Q(veh)	0.2	1.3	-	-	-						

Union Road Corridor Study
5: Union Road & Main Street

2026 Design Conditions - PM Peak Hour
1/16/2017

Lane Group	EBL	EBT	WBL	WBT	NBL	NBT	NBR	SBL	SBR
Lane Configurations	69	66	30	58	44	86	988	28	148
Volume (vph)	1900	1900	1900	1900	1900	1900	1900	1900	1900
Ideal Flow (vpph)	105	0	100	0	115	0	105	0	0
Storage Length (ft)	1	0	1	0	1	0	1	0	0
Storage Lanes	50	90	90	70	70	70	95	95	95
Taper Length (ft)	1.00	1.00	1.00	1.00	1.00	0.95	1.00	0.95	0.95
Lane Util. Factor	0.923		0.935		0.996		0.994		0.994
Flt Protected	0.950		0.950		0.950		0.950		0.950
Satd. Flow (prot)	1770	1719	0	1770	1742	0	1770	3525	0
Flt Permitted	0.365		0.406		0.099		0.165		0.165
Satd. Flow (perm)	680	1719	0	756	1742	0	184	3525	0
Right Turn on Red		Yes		Yes		Yes		Yes	Yes
Satd. Flow (RTOR)	27		20		4		5		5
Link Speed (mph)	35		35		40		40		40
Link Distance (ft)	947		812		1171		872		14.9
Travel Time (s)	18.4		15.8		20.0		14.9		14.9
Peak Hour Factor	0.77	0.77	0.85	0.85	0.81	0.81	0.81	0.89	0.89
Adj. Flow (vph)	90	86	90	35	68	52	106	1220	35
Shared Lane Traffic (%)									1524
Lane Group Flow (vph)	90	176	0	35	120	0	106	1255	0
Enter Blocked Intersection	No	No	No	No	No	No	No	No	No
Lane Alignment	Left	Left	Right	Left	Left	Left	Right	Left	Right
Median Width(ft)	12	12	12	12	12	12	12	12	12
Link Offset(ft)	0	0	0	0	0	0	0	0	0
Crosswalk Width(ft)	16		16		16		16		16
Two way Left Turn Lane						Yes		Yes	
Headway Factor	1.00	1.00	1.00	1.00	1.00	1.00	1.00	1.00	1.00
Turning Speed (mph)	15	9	15	9	15	9	15	9	15
Number of Detectors	1	2	1	2	1	2	1	2	2
Detector Template	Left	Thru	Left	Thru	Left	Thru	Left	Thru	Thru
Leading Detector (ft)	20	100	20	100	20	100	20	100	100
Trailing Detector (ft)	0	0	0	0	0	0	0	0	0
Detector 1 Position(ft)	0	0	0	0	0	0	0	0	0
Detector 1 Size(ft)	20	6	20	6	20	6	20	6	6
Detector 1 Type	CI+EX	CI+EX	CI+EX	CI+EX	CI+EX	CI+EX	CI+EX	CI+EX	CI+EX
Detector 1 Channel									
Detector 1 Extend (s)	0.0	0.0	0.0	0.0	0.0	0.0	0.0	0.0	0.0
Detector 1 Queue (s)	0.0	0.0	0.0	0.0	0.0	0.0	0.0	0.0	0.0
Detector 1 Delay (s)	0.0	0.0	0.0	0.0	0.0	0.0	0.0	0.0	0.0
Detector 2 Position(ft)	94		94		94		94		94
Detector 2 Size(ft)	6		6		6		6		6
Detector 2 Type	CI+EX		CI+EX		CI+EX		CI+EX		CI+EX
Detector 2 Channel									
Detector 2 Extend (s)	0.0		0.0		0.0		0.0		0.0
Turn Type	pm+pt	NA	pm+pt	NA	pm+pt	NA	pm+pt	NA	NA
Protected Phases	3	8	7	4	5	2	1	6	6
Permitted Phases	8	8	4	4	2	2	6	6	6
Detector Phase	3	8	7	4	5	2	1	6	6

Union Road Corridor Study
5: Union Road & Main Street

2026 Design Conditions - PM Peak Hour
1/16/2017

Lane Group	EBL	EBT	WBL	WBT	NBL	NBT	NBR	SBL	SBR
Switch Phase	3.0	10.0	3.0	10.0	3.0	20.0	3.0	20.0	3.0
Minimum Initial (s)	8.0	33.5	8.0	32.3	8.0	32.4	8.0	32.4	8.0
Minimum Split (s)	15.0	25.0	15.0	25.0	10.0	110.0	10.0	110.0	10.0
Total Split (s)	9.4%	15.6%	9.4%	15.6%	6.3%	68.8%	6.3%	68.8%	6.3%
Total Split (%)	10.4	19.7	10.4	19.7	5.1	104.6	5.1	104.6	5.1
Maximum Green (s)	3.6	3.6	3.6	3.6	3.9	3.9	3.9	3.9	3.9
Yellow Time (s)	1.0	1.7	1.0	1.7	1.0	1.5	1.0	1.5	1.0
All-Red Time (s)	0.0	0.0	0.0	0.0	0.0	0.0	0.0	0.0	0.0
Lost Time Adjust (s)	4.6	5.3	4.6	5.3	4.9	5.4	4.9	5.4	4.9
Total Lost Time (s)	Lead Lag	Lead Lag	Lead Lag	Lead Lag	Lead Lag	Lead Lag	Lead Lag	Lead Lag	Lead Lag
Lead-Lag Optimize?	Yes	Yes	Yes	Yes	Yes	Yes	Yes	Yes	Yes
Vehicle Extension (s)	3.0	2.0	3.0	2.0	2.0	4.0	2.0	4.0	2.0
Recall Mode	None	None	None	None	None	C-Min	None	C-Min	None
Walk Time (s)	7.0		7.0		7.0		7.0		7.0
Flash Dont Walk (s)	20.0		20.0		20.0		20.0		20.0
Pedestrian Calls (#/hr)	0		0		0		0		0
Act Effct Green (s)	29.8	19.7	23.5	14.8	113.4	106.5	115.8	107.7	107.7
Actuated g/C Ratio	0.19	0.12	0.15	0.09	0.71	0.67	0.72	0.67	0.67
v/c Ratio	0.45	0.75	0.22	0.67	0.55	0.53	0.57	0.57	0.57
Control Delay	60.9	76.8	54.2	76.2	17.4	15.4	18.8	11.6	11.6
Queue Delay	0.0	0.0	0.0	0.0	0.0	0.0	0.0	0.0	0.0
Total Delay	60.9	76.8	54.2	76.2	17.4	15.4	18.8	11.6	11.6
LOS	E	E	D	E	B	B	B	B	B
Approach Delay	71.4		71.2		15.6		12.3		12.3
Approach LOS	E		E		B		B		B

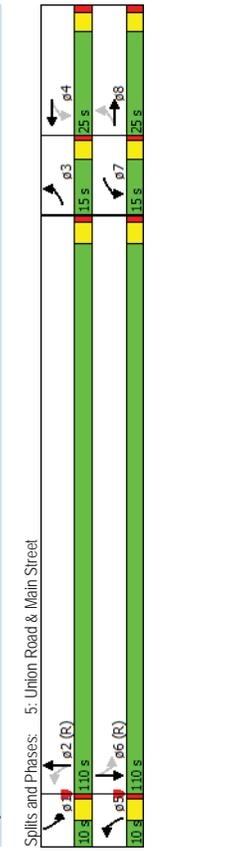

Union Road Corridor Study
6: Union Road & Seneca Street

2026 Design Conditions - PM Peak Hour
1/16/2017

Lane Group	EBL	EBT	WBL	WBT	WBR	NBL	NBT	NBR	SBL	SBR
Lane Configurations	↔	↔	↔	↔	↔	↔	↔	↔	↔	↔
Volume (vph)	259	251	134	178	211	55	103	787	121	149
Ideal Flow (vphpl)	1900	1900	1900	1900	1900	1900	1900	1900	1900	1900
Storage Length (ft)	175	0	115	0	130	0	160	0	160	0
Storage Lanes	1	0	1	0	1	0	1	0	1	0
Taper Length (ft)	150	0	110	0	95	0	115	0	115	0
Lane Util. Factor	1.00	0.95	1.00	0.95	1.00	0.95	0.95	1.00	0.95	0.95
Flt	0.948		0.969		0.980		0.984		0.984	
Flt Protected	0.950		0.950		0.950		0.950		0.950	
Satd. Flow (prot)	1770	3355	0	1770	3429	0	1770	3468	0	1770
Flt Permitted	0.382		0.230		0.055		0.196		0.196	
Satd. Flow (perm)	712	3355	0	428	3429	0	3468	0	365	3463
Right Turn on Red		Yes		Yes		Yes		Yes		Yes
Satd. Flow (RTOR)	61		20		16		16		13	
Link Speed (mph)	35		35		45		45		40	
Link Distance (ft)	1121		353		1399		21.2		20.0	
Travel Time (s)	21.8		6.9		21.2		21.2		20.0	
Peak Hour Factor	0.80	0.80	0.93	0.93	0.93	0.91	0.91	0.91	0.90	0.90
Adj. Flow (vph)	324	314	168	191	227	59	113	865	133	166
Shared Lane Traffic (%)										
Lane Group Flow (vph)	324	482	0	191	286	0	113	998	0	166
Enter Blocked Intersection	No	No	No	No	No	No	No	No	No	No
Lane Alignment	Left	Left	Right	Left	Right	Left	Left	Right	Left	Right
Median Width(ft)	12	12	12	12	12	12	12	12	12	12
Link Offset(ft)	0	0	0	0	0	0	0	0	0	0
Crosswalk Width(ft)	16		16		16		16		16	
Two way Left Turn Lane										
Headway Factor	1.00	1.00	1.00	1.00	1.00	1.00	1.00	1.00	1.00	1.00
Turning Speed (mph)	15	9	15	1	9	15	1	9	15	9
Number of Detectors	1	2	1	2	1	2	1	2	1	2
Detector Template	Left	Thru	Left	Thru	Left	Thru	Left	Thru	Left	Thru
Leading Detector (ft)	20	100	20	100	20	100	20	100	20	100
Trailing Detector (ft)	0	0	0	0	0	0	0	0	0	0
Detector 1 Position(ft)	0	0	0	0	0	0	0	0	0	0
Detector 1 Size(ft)	20	6	20	6	20	6	20	6	20	6
Detector 1 Type	Ch+Ex	Ch+Ex	Ch+Ex	Ch+Ex	Ch+Ex	Ch+Ex	Ch+Ex	Ch+Ex	Ch+Ex	Ch+Ex
Detector 1 Channel										
Detector 1 Extend (s)	0.0	0.0	0.0	0.0	0.0	0.0	0.0	0.0	0.0	0.0
Detector 1 Queue (s)	0.0	0.0	0.0	0.0	0.0	0.0	0.0	0.0	0.0	0.0
Detector 1 Delay (s)	0.0	0.0	0.0	0.0	0.0	0.0	0.0	0.0	0.0	0.0
Detector 2 Position(ft)	94		94		94		94		94	
Detector 2 Size(ft)	6		6		6		6		6	
Detector 2 Type	Ch+Ex		Ch+Ex		Ch+Ex		Ch+Ex		Ch+Ex	
Detector 2 Channel										
Detector 2 Extend (s)	0.0		0.0		0.0		0.0		0.0	
Turn Type	pm+pt	NA	pm+pt	NA	pm+pt	NA	pm+pt	NA	pm+pt	NA
Protected Phases	7	4	3	8	5	2	1	6	1	6
Permitted Phases	4		8		2		6		6	
Detector Phase	7	4	3	8	5	2	1	6	1	6

Union Road Corridor Study
6: Union Road & Seneca Street

2026 Design Conditions - PM Peak Hour
1/16/2017

Lane Group	EBL	EBT	WBL	WBT	WBR	NBL	NBT	NBR	SBL	SBR
Switch Phase										
Minimum Initial (s)	3.0	10.0	3.0	10.0	3.0	3.0	20.0	3.0	3.0	20.0
Minimum Split (s)	8.0	32.3	8.0	32.3	8.0	8.0	28.5	8.0	8.0	28.5
Total Split (s)	20.0	30.0	20.0	30.0	20.0	20.0	70.0	20.0	20.0	70.0
Total Split (%)	14.3%	21.4%	14.3%	21.4%	14.3%	14.3%	50.0%	14.3%	14.3%	50.0%
Maximum Green (s)	15.7	24.7	15.7	24.7	15.7	15.7	64.5	15.7	15.7	64.5
Yellow Time (s)	3.2	3.6	3.2	3.6	3.2	3.2	4.3	3.2	3.2	4.3
All-Red Time (s)	1.1	1.7	1.1	1.7	1.1	1.1	1.2	1.1	1.1	1.2
Lost Time Adjust (s)	0.0	0.0	0.0	0.0	0.0	0.0	0.0	0.0	0.0	0.0
Total Lost Time (s)	4.3	5.3	4.3	5.3	4.3	4.3	5.5	4.3	4.3	5.5
Lead/Lag	Lead	Lag	Lead	Lag	Lead	Lead	Lag	Lead	Lag	Lag
Lead-Lag Optimize?	Yes	Yes	Yes	Yes	Yes	Yes	Yes	Yes	Yes	Yes
Vehicle Extension (s)	2.0	4.0	2.0	4.0	2.0	2.0	4.0	2.0	2.0	4.0
Recall Mode	None	None	None	None	None	None	C-Min	None	None	C-Min
Walk Time (s)	7.0		7.0		7.0		7.0		7.0	
Flash Dont Walk (s)	20.0		20.0		20.0		16.0		16.0	
Pedestrian Calls (#/hr)	0		0		0		0		0	
Act Effct Green (s)	40.6	24.1	36.9	21.5	82.6	72.1	84.1	72.9	84.1	72.9
Actuated g/C Ratio	0.29	0.17	0.26	0.15	0.59	0.52	0.60	0.52	0.60	0.52
v/c Ratio	0.97	0.77	0.76	0.53	0.66	0.56	0.52	0.56	0.52	0.85
Control Delay	85.4	57.1	57.5	53.6	43.8	24.8	17.4	35.3	17.4	35.3
Queue Delay	0.0	0.0	0.0	0.0	0.0	0.0	0.0	0.0	0.0	0.0
Total Delay	85.4	57.1	57.5	53.6	43.8	24.8	17.4	35.3	17.4	35.3
LOS	F	E	E	D	D	C	C	B	B	D
Approach Delay	68.4		55.1		26.8		33.6		33.6	
Approach LOS	E		E		C		C		C	

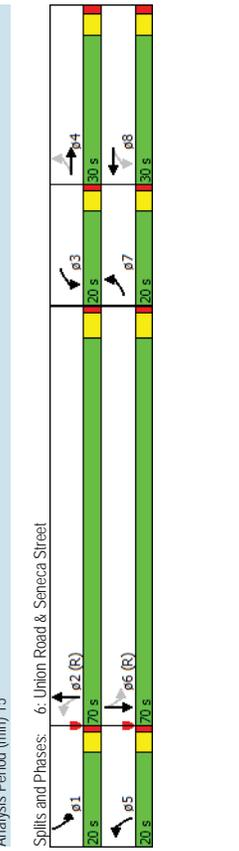

Union Road Corridor Study
 7: Union Road & Southgate Plaza/Willowdale Drive

2026 Design Conditions - PM Peak Hour
 1/16/2017

Lane Group	EBL	EBT	EBR	WBL	WBT	WBR	NBL	NBT	NBR	SBL	SBR
Lane Configurations	101	28	153	21	11	4	156	764	11	8	1244
Volume (vph)	1900	1900	1900	1900	1900	1900	1900	1900	1900	1900	1900
Ideal Flow (vpph)	65	0	0	0	0	70	0	50	0	50	0
Storage Length (ft)	1	0	0	0	0	1	0	1	0	1	0
Storage Lanes	25	0	0	25	0	25	0	100	0	100	0
Taper Length (ft)	1.00	1.00	1.00	1.00	1.00	1.00	1.00	0.95	0.95	1.00	0.95
Lane Util. Factor	0.873			0.985		0.971		0.998		0.997	
Flt Protected	0.950			0.971		0.950		0.950		0.950	
Satd. Flow (prot)	1770	1626	0	1782	0	1770	3532	0	1770	3529	0
Flt Permitted	0.804			0.463		0.106		0.269		0.269	
Satd. Flow (perm)	1498	1626	0	850	0	197	3532	0	501	3529	0
Right Turn on Red		Yes		Yes		Yes		Yes		Yes	
Satd. Flow (RTOR)	163			6		2		4		4	
Link Speed (mph)	15			30		45		45		45	
Link Distance (ft)	325			582		648		1399		1399	
Travel Time (s)	14.8			13.2		9.8		21.2		21.2	
Peak Hour Factor	0.94	0.94	0.94	0.57	0.57	0.89	0.89	0.89	0.89	0.92	0.92
Adj. Flow (vph)	107	30	163	37	19	7	175	858	12	9	1352
Shared Lane Traffic (%)											
Lane Group Flow (vph)	107	193	0	0	63	0	175	870	0	9	1382
Enter Blocked Intersection	No	No	No	No	No	No	No	No	No	No	No
Lane Alignment	Left	Left	Right	Left	Right	Left	Left	Right	Left	Left	Right
Median Width(ft)	12	12	12	12	12	12	12	12	12	12	12
Link Offset(ft)	0	0	0	0	0	0	0	0	0	0	0
Crosswalk Width(ft)	16			16		16		16		16	
Two way Left Turn Lane											Yes
Headway Factor	1.00	1.00	1.00	1.00	1.00	1.00	1.00	1.00	1.00	1.00	1.00
Turning Speed (mph)	15	9	15	15	9	15	15	9	15	15	9
Number of Detectors	1	2		1	2		1	2		1	2
Detector Template	Left	Thru	Left	Thru	Left	Thru	Left	Thru	Left	Thru	Left
Leading Detector (ft)	20	100	20	100	20	100	20	100	20	100	20
Trailing Detector (ft)	0	0	0	0	0	0	0	0	0	0	0
Detector 1 Position(ft)	0	0	0	0	0	0	0	0	0	0	0
Detector 1 Size(ft)	20	6	20	6	20	6	20	6	20	6	20
Detector 1 Type	Ch+Ex	Ch+Ex	Ch+Ex	Ch+Ex	Ch+Ex	Ch+Ex	Ch+Ex	Ch+Ex	Ch+Ex	Ch+Ex	Ch+Ex
Detector 1 Channel											
Detector 1 Extend (s)	0.0	0.0	0.0	0.0	0.0	0.0	0.0	0.0	0.0	0.0	0.0
Detector 1 Queue (s)	0.0	0.0	0.0	0.0	0.0	0.0	0.0	0.0	0.0	0.0	0.0
Detector 1 Delay (s)	0.0	0.0	0.0	0.0	0.0	0.0	0.0	0.0	0.0	0.0	0.0
Detector 2 Position(ft)	94			94		94		94		94	
Detector 2 Size(ft)	6			6		6		6		6	
Detector 2 Type	Ch+Ex			Ch+Ex		Ch+Ex		Ch+Ex		Ch+Ex	
Detector 2 Channel											
Detector 2 Extend (s)	0.0	0.0	0.0	0.0	0.0	0.0	0.0	0.0	0.0	0.0	0.0
Turn Type	Perm	NA	Perm	NA	pm+pt	NA	Perm	NA	Perm	NA	NA
Protected Phases	3	3		3		3		3		3	2
Permitted Phases	3	3		3		3		3		3	2
Detector Phase	3	3		3		3		3		3	2

Union Road Corridor Study
 7: Union Road & Southgate Plaza/Willowdale Drive

2026 Design Conditions - PM Peak Hour
 1/16/2017

Lane Group	EBL	EBT	EBR	WBL	WBT	WBR	NBL	NBT	NBR	SBL	SBR
Switch Phase											
Minimum Initial (s)	6.0	6.0	6.0	6.0	6.0	6.0	3.0	20.0	3.0	20.0	20.0
Minimum Split (s)	32.3	32.3	32.3	32.3	32.3	32.3	8.0	25.5	8.0	25.5	25.5
Total Split (s)	20.0	20.0	20.0	20.0	20.0	20.0	15.0	55.0	15.0	55.0	55.0
Total Split (%)	22.2%	22.2%	22.2%	22.2%	22.2%	22.2%	16.7%	61.1%	16.7%	61.1%	61.1%
Maximum Green (s)	14.7	14.7	14.7	14.7	14.7	14.7	10.7	49.5	10.7	49.5	49.5
Yellow Time (s)	3.6	3.6	3.6	3.6	3.6	3.6	3.2	4.3	3.2	4.3	4.3
All-Red Time (s)	1.7	1.7	1.7	1.7	1.7	1.7	1.1	1.2	1.1	1.2	1.2
Lost Time Adjust (s)	0.0	0.0	0.0	0.0	0.0	0.0	0.0	0.0	0.0	0.0	0.0
Total Lost Time (s)	5.3	5.3	5.3	5.3	5.3	5.3	4.3	5.5	4.3	5.5	5.5
Lead/Lag							Lead	Lag	Lead	Lag	Lag
Lead-Lag Optimize?	Yes	Yes	Yes	Yes	Yes	Yes	Yes	Yes	Yes	Yes	Yes
Vehicle Extension (s)	3.0	3.0	3.0	3.0	3.0	3.0	2.0	4.0	2.0	4.0	4.0
Recall Mode	None	None	None	None	None	None	C-Max	Min	C-Max	Min	Min
Walk Time (s)	7.0	7.0	7.0	7.0	7.0	7.0					
Flash Dont Walk (s)	20.0	20.0	20.0	20.0	20.0	20.0					
Pedestrian Calls (#/hr)	0	0	0	0	0	0					
Act Effct Green (s)	11.7	11.7	11.7	11.7	11.7	11.7	64.4	48.9	64.4	48.9	48.9
Actuated g/C Ratio	0.13	0.13	0.13	0.13	0.13	0.13	0.72	0.54	0.72	0.54	0.54
v/c Ratio	0.55	0.55	0.55	0.55	0.55	0.55	0.45	0.45	0.45	0.45	0.72
Control Delay	46.7	14.8	14.8	50.6	50.6	50.6	13.3	13.2	13.3	13.2	9.9
Queue Delay	0.0	0.0	0.0	0.0	0.0	0.0	0.0	0.0	0.0	0.0	0.0
Total Delay	46.7	14.8	14.8	50.6	50.6	50.6	13.3	13.2	13.3	13.2	9.9
LOS	D	B	B	D	D	D	B	B	B	B	A
Approach Delay							26.2				17.9
Approach LOS							C				B
Intersection Summary	Other										
Area Type:	Other										
Cycle Length:	90										
Actuated Cycle Length:	90										
Offset:	75 (83%), Referenced to phase 1:NBL, Start of Green										
Natural Cycle:	90										
Control Type:	Actuated-Coordinated										
Maximum v/c Ratio:	0.72										
Intersection Signal Delay:	17.8										
Intersection Capacity Utilization:	76.3%										
Analysis Period (min):	15										
Spills and Phases:	7: Union Road & Southgate Plaza/Willowdale Drive										
	15 s	15 s	15 s	15 s	15 s	15 s	55 s	55 s	55 s	55 s	55 s
	15 s	15 s	15 s	15 s	15 s	15 s	55 s	55 s	55 s	55 s	55 s

Union Road Corridor Study
1: Union Road & NYS 400

2026 Design Conditions (With Road Diet) - PM Peak Hour
1/16/2017

Lane Group	EBL	EBR	NBL	NBT	SBT	SBR
Lane Configurations	WV	WV	WV	WV	WV	WV
Volume (vph)	293	815	387	850	1135	393
Ideal Flow (vphpl)	1900	1900	1900	1900	1900	1900
Storage Length (ft)	0	0	75	0	230	0
Storage Lanes	2	1	1	1	1	1
Taper Length (ft)	25	80	80	0	0	0
Lane Util. Factor	0.97	0.91	1.00	0.95	0.95	1.00
Flt	0.913	0.850	0.950	0.850	0.850	0.850
Flt Protected	0.980	0.950	0.950	0.950	0.950	0.950
Satd. Flow (prot)	3082	1441	1770	3539	3539	1495
Flt Permitted	0.980	0.116	0.116	0.116	0.116	0.116
Satd. Flow (perm)	3082	1441	216	3539	3539	1495
Right Turn on Red	Yes	Yes	Yes	Yes	Yes	Yes
Satd. Flow (RTOR)	349	11	0	0	0	99
Link Speed (mph)	45	40	40	40	40	40
Link Distance (ft)	338	874	874	995	995	995
Travel Time (s)	5.1	14.9	14.9	17.0	17.0	17.0
Peak Hour Factor	0.89	0.89	0.96	0.96	0.89	0.89
Heavy Vehicles (%)	14%	2%	2%	2%	2%	8%
Adj. Flow (vph)	329	916	403	885	1275	442
Shared Lane Traffic (%)	50%					
Lane Group Flow (vph)	787	458	403	885	1275	442
Enter Blocked Intersection	No	No	No	No	No	No
Lane Alignment	Left	Right	Left	Left	Left	Right
Median Width(ft)	24	12	12	12	12	12
Link Offset(ft)	0	0	0	0	0	0
Crosswalk Width(ft)	16	16	16	16	16	16
Two way Left Turn Lane	Yes	Yes	Yes	Yes	Yes	Yes
Headway Factor	1.00	1.00	1.00	1.00	1.00	1.00
Turning Speed (mph)	15	9	15	9	15	9
Number of Detectors	1	1	2	2	1	1
Detector Template	Left	Right	Left	Thru	Right	Right
Leading Detector (ft)	20	20	100	100	20	20
Trailing Detector (ft)	0	0	0	0	0	0
Detector 1 Position(ft)	0	0	0	0	0	0
Detector 1 Size(ft)	20	20	20	6	6	20
Detector 1 Type	Cl+Ex	Cl+Ex	Cl+Ex	Cl+Ex	Cl+Ex	Cl+Ex
Detector 1 Channel						
Detector 1 Extend (s)	0.0	0.0	0.0	0.0	0.0	0.0
Detector 1 Queue (s)	0.0	0.0	0.0	0.0	0.0	0.0
Detector 1 Delay (s)	0.0	0.0	0.0	0.0	0.0	0.0
Detector 2 Position(ft)	94	94	94	94	94	94
Detector 2 Size(ft)	6	6	6	6	6	6
Detector 2 Type	Cl+Ex	Cl+Ex	Cl+Ex	Cl+Ex	Cl+Ex	Cl+Ex
Detector 2 Channel						
Detector 2 Extend (s)	0.0	0.0	0.0	0.0	0.0	0.0
Turn Type	Prot	pm+ov	pm+pt	NA	NA	pm+ov
Protected Phases	3	1	1	2	2	3
Permitted Phases		3	2			2

Lanes, Volumes, Timings
SRF & Associates

Synchro 8 Report
Page 1

Union Road Corridor Study
1: Union Road & NYS 400

2026 Design Conditions (With Road Diet) - PM Peak Hour
1/16/2017

Lane Group	EBL	EBR	NBL	NBT	SBT	SBR
Detector Phase	3	1	1	2	2	3
Switch Phase						
Minimum Initial (s)	10.0	6.0	6.0	20.0	20.0	10.0
Minimum Split (s)	20.0	20.0	20.0	34.5	34.5	20.0
Total Split (s)	30.0	20.0	20.0	40.0	40.0	30.0
Total Split (%)	33.3%	22.2%	22.2%	44.4%	44.4%	33.3%
Maximum Green (s)	24.5	15.7	15.7	34.5	34.5	24.5
Yellow Time (s)	3.9	3.2	3.2	3.9	3.9	3.9
All-Red Time (s)	1.6	1.1	1.1	1.6	1.6	1.6
Lost Time Adjust (s)	0.0	0.0	0.0	0.0	0.0	0.0
Total Lost Time (s)	5.5	4.3	4.3	5.5	5.5	5.5
Lead/Lag	Lead	Lead	Lead	Lag	Lag	Lag
Lead-Lag Optimize?	Yes	Yes	Yes	Yes	Yes	Yes
Vehicle Extension (s)	3.5	3.5	3.5	4.0	4.0	3.5
Recall Mode	None	C-Max	C-Max	Min	Min	None
Walk Time (s)				7.0	7.0	
Flash Dont Walk (s)				22.0	22.0	
Pedestrian Calls (#/hr)				0	0	
Act Effct Green (s)	20.7	45.7	55.2	34.5	34.5	60.7
Actuated g/C Ratio	0.23	0.51	0.61	0.38	0.38	0.67
v/c Ratio	0.80	0.62	0.86	0.65	0.94	0.42
Control Delay	24.4	20.1	43.7	25.6	41.5	5.9
Queue Delay	0.0	0.0	0.0	0.0	0.0	0.0
Total Delay	24.4	20.1	43.7	25.6	41.5	5.9
LOS	C	C	D	C	D	A
Approach Delay	22.8			31.3	32.4	
Approach LOS	C			C	C	
Intersection Summary	Other					
Area Type:	Other					
Cycle Length:	90					
Actuated Cycle Length:	90					
Offset:	70 (78%), Referenced to phase 1:NBL, Start of Green					
Natural Cycle:	75					
Control Type:	Actuated-Coordinated					
Maximum v/c Ratio:	0.94					
Intersection Signal Delay:	29.2					
Intersection Capacity Utilization:	82.5%					
Analysis Period (min):	15					



Splits and Phases: 1: Union Road & NYS 400

Lanes, Volumes, Timings
SRF & Associates

Synchro 8 Report
Page 2

Union Road Corridor Study
2: Union Road & Center Road

2026 Design Conditions (With Road Diet) - PM Peak Hour
1/16/2017

Lane Group	EBL	EBT	EBL	WBL	WBT	WBR	NBL	NBT	NBR	SBL	SBR
Lane Configurations	177	151	108	90	135	111	99	943	91	284	1383
Volume (vph)	1900	1900	1900	1900	1900	1900	1900	1900	1900	1900	1900
Ideal Flow (vphpl)	140	140	0	90	0	100	0	170	0	170	0
Storage Length (ft)	1	0	0	1	0	1	0	1	0	1	0
Taper Length (ft)	60	95	95	90	90	110	110	110	110	110	110
Lane Util. Factor	1.00	0.95	1.00	0.95	1.00	0.95	0.95	0.95	1.00	0.95	0.95
Flt Protected	0.937			0.932			0.987			0.990	
Satd. Flow (prot)	1770	3316	0	1770	3299	0	1770	3493	0	1770	3504
Flt Permitted	0.219			0.564			0.089			0.129	
Satd. Flow (perm)	408	3316	0	1051	3299	0	166	3493	0	240	3504
Right Turn on Red	Yes			Yes			Yes			Yes	
Satd. Flow (RTOR)	104			114			8			6	
Link Speed (mph)	40			40			40			40	
Link Distance (ft)	319			325			387			874	
Travel Time (s)	5.4			5.5			6.6			14.9	
Peak Hour Factor	0.91	0.91	0.91	0.91	0.91	0.91	0.91	0.91	0.91	0.92	0.92
Adj. Flow (vph)	195	166	119	99	148	122	109	1036	100	309	1503
Shared Lane Traffic (%)											
Lane Group Flow (vph)	195	285	0	99	270	0	109	1136	0	309	1605
Enter Blocked Intersection	No	No	No	No	No	No	No	No	No	No	No
Lane Alignment	Left	Left	Right	Left	Right	Left	Left	Right	Left	Left	Right
Median Width (ft)	12	12	12	12	12	12	12	12	12	12	12
Link Offset (ft)	0			0			0			0	
Crosswalk Width (ft)	16			16			16			16	
Two way Left Turn Lane				Yes			Yes			Yes	
Headway Factor	1.00	1.00	1.00	1.00	1.00	1.00	1.00	1.00	1.00	1.00	1.00
Turning Speed (mph)	15	9	15	1	2	9	15	9	15	15	9
Number of Detectors	1	2	1	2	1	2	1	2	1	2	1
Detector Template	Left	Thru	Left	Thru	Left	Thru	Left	Thru	Left	Thru	Left
Leading Detector (ft)	20	100	20	100	20	100	20	100	20	100	20
Trailing Detector (ft)	0	0	0	0	0	0	0	0	0	0	0
Detector 1 Position (ft)	0	0	0	0	0	0	0	0	0	0	0
Detector 1 Size (ft)	20	6	20	6	20	6	20	6	20	6	20
Detector 1 Type	Ch+Ex	Ch+Ex	Ch+Ex	Ch+Ex	Ch+Ex	Ch+Ex	Ch+Ex	Ch+Ex	Ch+Ex	Ch+Ex	Ch+Ex
Detector 1 Channel											
Detector 1 Extend (s)	0.0	0.0	0.0	0.0	0.0	0.0	0.0	0.0	0.0	0.0	0.0
Detector 1 Queue (s)	0.0	0.0	0.0	0.0	0.0	0.0	0.0	0.0	0.0	0.0	0.0
Detector 1 Delay (s)	0.0	0.0	0.0	0.0	0.0	0.0	0.0	0.0	0.0	0.0	0.0
Detector 2 Position (ft)	94			94			94			94	
Detector 2 Size (ft)	6			6			6			6	
Detector 2 Type	Ch+Ex			Ch+Ex			Ch+Ex			Ch+Ex	
Detector 2 Channel											
Detector 2 Extend (s)	0.0	0.0	0.0	0.0	0.0	0.0	0.0	0.0	0.0	0.0	0.0
Turn Type	pm+pt	NA	pm+pt	NA	pm+pt	NA	pm+pt	NA	pm+pt	NA	pm+pt
Protected Phases	3	8	7	4	5	2	1	6			6
Permitted Phases	8	8	4	4	2	2	6			6	
Detector Phase	3	8	7	4	5	2	1	6			6

Union Road Corridor Study
2: Union Road & Center Road

2026 Design Conditions (With Road Diet) - PM Peak Hour
1/16/2017

Lane Group	EBL	EBT	EBL	WBL	WBT	WBR	NBL	NBT	NBR	SBL	SBR
Switch Phase	3.0	10.0		3.0	10.0		3.0	20.0		3.0	20.0
Minimum Initial (s)	8.0	35.4		8.0	35.4		8.0	27.2		8.0	27.2
Minimum Split (s)	27.0	41.0		19.0	33.0		16.0	78.0		22.0	84.0
Total Split (s)	16.9%	25.6%		11.9%	20.6%		10.0%	48.8%		13.8%	52.5%
Total Split (%)	22.0	35.6		14.0	27.6		11.7	72.8		17.7	78.8
Maximum Green (s)	3.5	3.9		3.5	3.9		3.2	3.9		3.2	3.9
Yellow Time (s)	1.5	1.5		1.5	1.5		1.1	1.3		1.1	1.3
All-Red Time (s)	0.0	0.0		0.0	0.0		0.0	0.0		0.0	0.0
Lost Time Adjust (s)	5.0	5.4		5.0	5.4		4.3	5.2		4.3	5.2
Total Lost Time (s)	Lead/Lag	Lead/Lag	Lead/Lag	Lead/Lag	Lead/Lag	Lead/Lag	Lead/Lag	Lead/Lag	Lead/Lag	Lead/Lag	Lead/Lag
Lead/Lag	Yes	Yes	Yes	Yes	Yes	Yes	Yes	Yes	Yes	Yes	Yes
Lead-Lag Optimize?	3.0	4.0		3.0	4.0		3.0	4.0		3.0	4.0
Vehicle Extension (s)	None	None		None	None		None	C-Min		None	C-Min
Recall Mode	10.0			10.0			7.0			7.0	
Walk Time (s)	20.0			20.0			15.0			15.0	
Flash Dont Walk (s)	0			0			0			0	
Pedestrian Calls (#/hr)	38.5	21.2		26.7	14.3		89.9	78.1		112.1	96.0
Act Effct Green (s)	0.24	0.13		0.17	0.09		0.56	0.49		0.70	0.60
Actuated g/C Ratio	0.76	0.54		0.43	0.68		0.54	0.67		0.70	0.76
v/c Ratio	69.1	43.7		53.6	48.9		21.9	42.6		31.9	28.5
Control Delay	0.0	0.0		0.0	0.0		0.0	0.0		0.0	1.6
Queue Delay	69.1	43.7		53.6	48.9		21.9	42.6		31.9	30.1
Total Delay	E	D		D	D		C	D		C	C
LOS	54.0			50.2			40.8			30.4	
Approach Delay	D			D			D			D	
Approach LOS											

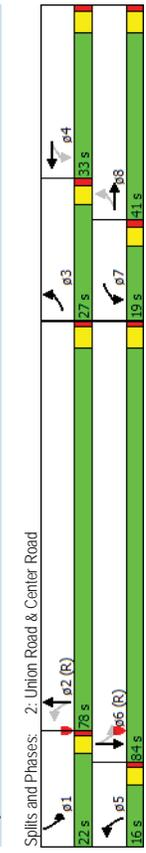

Union Road Corridor Study 2026 Design Conditions (With Road Diet) - PM Peak Hour
 3: Union Road & Nonwood Drive 1/16/2017

Intersection									
Int Delay, s/veh 0.7									
Movement	WBL	WBR	NBT	NBR	SBL	SBT			
Vol, veh/h	9	16	1086	24	25	1553			
Conflicting Peds, #/hr	0	0	0	0	0	0			
Sign Control	Stop	Stop	Free	Free	Free	Free			
RT Channelized	-	None	-	None	-	None			
Storage Length	0	-	-	-	100	-			
Veh in Median Storage, #	0	-	0	0	-	0			
Grade, %	0	-	-	-	-	0			
Peak Hour Factor	52	52	94	94	91	91			
Heavy Vehicles, %	2	2	2	2	2	2			
Mvmt Flow	17	31	1155	26	27	1707			
Major/Minor	Minor1	Minor2	Major1	Major2					
Conflicting Flow All	2930	1168	0	0	1181	0			
Stage 1	1168	-	-	-	-	-			
Stage 2	1762	-	-	-	-	-			
Critical Hdwy	6.42	6.22	-	-	4.12	-			
Critical Hdwy Stg 1	5.42	-	-	-	-	-			
Critical Hdwy Stg 2	5.42	-	-	-	-	-			
Follow-up Hdwy	3.518	3.318	-	-	2.218	-			
Pot Cap-1 Maneuver	- 17	235	-	-	591	-			
Stage 1	296	-	-	-	-	-			
Stage 2	151	-	-	-	-	-			
Platoon blocked, %	-	-	-	-	-	-			
Mov Cap-1 Maneuver	- 16	235	-	-	591	-			
Mov Cap-2 Maneuver	95	-	-	-	-	-			
Stage 1	296	-	-	-	-	-			
Stage 2	144	-	-	-	-	-			
Approach	WB	NB	SB						
HCM Control Delay, s	38.6	0	0.2						
HCM LOS	E								
Minor Lane/Major Mvmt	NBT	NBR	WBL1	SBL	SBT				
Capacity (veh/h)	-	154	591	-	-				
HCM Lane V/C Ratio	-	0.312	0.046	-	-				
HCM Control Delay (s)	-	38.6	11.4	-	-				
HCM Lane LOS	-	E	B	-	-				
HCM 95th %tile Q(veh)	-	1.2	0.1	-	-				
Notes									
-: Volume exceeds capacity \$: Delay exceeds 300s +: Computation Not Defined *: All major volume in platoon									

Union Road Corridor Study 2026 Design Conditions (With Road Diet) - PM Peak Hour
 4: Union Road & Legion Parkway 1/16/2017

Intersection										
Int Delay, s/veh 1.1										
Movement	EBL	EBR	NBL	NBT	SBL	SBT				
Vol, veh/h	18	14	17	1091	1537	25				
Conflicting Peds, #/hr	0	0	0	0	0	0				
Sign Control	Stop	Stop	Free	Free	Free	Free				
RT Channelized	-	None	-	None	-	None				
Storage Length	0	-	100	-	-	-				
Veh in Median Storage, #	0	-	0	0	0	0				
Grade, %	0	-	-	-	0	0				
Peak Hour Factor	68	68	94	94	91	91				
Heavy Vehicles, %	2	2	2	2	2	2				
Mvmt Flow	26	21	18	1161	1689	27				
Major/Minor	Minor2	Minor1	Major1	Major2						
Conflicting Flow All	2900	1703	1716	0	-	0				
Stage 1	1703	-	-	-	-	-				
Stage 2	1197	-	-	-	-	-				
Critical Hdwy	6.42	6.22	4.12	-	-	-				
Critical Hdwy Stg 1	5.42	-	-	-	-	-				
Critical Hdwy Stg 2	5.42	-	-	-	-	-				
Follow-up Hdwy	3.518	3.318	2.218	-	-	-				
Pot Cap-1 Maneuver	- 17	113	369	-	-	-				
Stage 1	162	-	-	-	-	-				
Stage 2	286	-	-	-	-	-				
Platoon blocked, %	-	-	-	-	-	-				
Mov Cap-1 Maneuver	- 16	113	369	-	-	-				
Mov Cap-2 Maneuver	99	-	-	-	-	-				
Stage 1	162	-	-	-	-	-				
Stage 2	272	-	-	-	-	-				
Approach	EB	NB	SB							
HCM Control Delay, s	64.6	0.2	0							
HCM LOS	F									
Minor Lane/Major Mvmt	NBL	NBT	EBL1	EBT	SBL	SBT				
Capacity (veh/h)	369	-	105	-	-	-				
HCM Lane V/C Ratio	0.049	-	0.448	-	-	-				
HCM Control Delay (s)	15.3	-	64.6	-	-	-				
HCM Lane LOS	C	-	F	-	-	-				
HCM 95th %tile Q(veh)	0.2	-	1.9	-	-	-				
Notes										
-: Volume exceeds capacity \$: Delay exceeds 300s +: Computation Not Defined *: All major volume in platoon										

Union Road Corridor Study 2026 Design Conditions (With Road Diet) - PM Peak Hour
5: Union Road & Main Street

1/16/2017

Lane Group	EBL	EBT	EBL	WBL	WBT	WBR	NBL	NBT	NBR	SBL	SBR
Lane Configurations	69	66	69	30	58	44	86	988	28	148	1356
Volume (vph)	1900	1900	1900	1900	1900	1900	1900	1900	1900	1900	1900
Ideal Flow (vpmpl)	105	0	100	0	115	0	105	0	105	0	0
Storage Length (ft)	1	0	1	0	1	0	1	0	1	0	0
Storage Lanes	50	90	90	70	70	70	95	0	0	0	0
Taper Length (ft)	1.00	1.00	1.00	1.00	1.00	1.00	1.00	1.00	1.00	1.00	1.00
Lane Util. Factor	0.923	0.950	0.935	0.950	0.950	0.950	0.994	0.950	0.950	0.994	0.994
Flt Protected	1770	1719	0	1770	1742	0	1770	1855	0	1770	1852
Satd. Flow (prot)	0.404	0.377	0.039	0.377	0.377	0.039	0.377	0.377	0.039	0.377	0.377
Flt Permitted	753	1719	0	702	1742	0	73	1855	0	71	1852
Satd. Flow (perm)	27	Yes	Yes	20	20	20	2	2	2	3	3
Right Turn on Red	35	35	35	35	35	35	40	40	40	40	40
Satd. Flow (RTOR)	18.4	18.4	18.4	15.8	15.8	15.8	9.4	9.4	9.4	14.9	14.9
Link Speed (mph)	0.77	0.77	0.77	0.85	0.85	0.85	0.81	0.81	0.81	0.89	0.89
Link Distance (ft)	90	86	90	35	68	52	106	1220	35	166	1524
Travel Time (s)	Adj. Flow (vph)	90	176	0	35	120	0	106	1255	0	166
Peak Hour Factor	No	No	No	No	No	No	No	No	No	No	No
Adj. Flow (vph)	Left	Left	Left	Right	Right	Right	Left	Left	Right	Left	Right
Lane Group Flow (vph)	12	12	12	12	12	12	12	12	12	12	12
Enter Blocked Intersection	0	0	0	0	0	0	0	0	0	0	0
Lane Alignment	16	16	16	16	16	16	16	16	16	16	16
Median Width (ft)	1.00	1.00	1.00	1.00	1.00	1.00	1.00	1.00	1.00	1.00	1.00
Link Offset (ft)	15	9	15	1	2	9	15	9	15	15	9
Crosswalk Width (ft)	1	2	1	2	1	2	1	2	1	2	1
Two way Left Turn Lane	Left	Thru	Left	Thru	Left	Thru	Left	Thru	Left	Thru	Left
Headway Factor	20	100	20	100	20	100	20	100	20	100	20
Turning Speed (mph)	0	0	0	0	0	0	0	0	0	0	0
Number of Detectors	20	6	20	6	20	6	20	6	20	6	20
Detector Template	Ch+Ex	Ch+Ex	Ch+Ex	Ch+Ex	Ch+Ex	Ch+Ex	Ch+Ex	Ch+Ex	Ch+Ex	Ch+Ex	Ch+Ex
Leading Detector (ft)	0	0	0	0	0	0	0	0	0	0	0
Trailing Detector (ft)	0	0	0	0	0	0	0	0	0	0	0
Detector 1 Position (ft)	0	0	0	0	0	0	0	0	0	0	0
Detector 1 Size (ft)	20	6	20	6	20	6	20	6	20	6	20
Detector 1 Type	Ch+Ex	Ch+Ex	Ch+Ex	Ch+Ex	Ch+Ex	Ch+Ex	Ch+Ex	Ch+Ex	Ch+Ex	Ch+Ex	Ch+Ex
Detector 1 Channel	0.0	0.0	0.0	0.0	0.0	0.0	0.0	0.0	0.0	0.0	0.0
Detector 1 Extend (s)	0.0	0.0	0.0	0.0	0.0	0.0	0.0	0.0	0.0	0.0	0.0
Detector 1 Queue (s)	0.0	0.0	0.0	0.0	0.0	0.0	0.0	0.0	0.0	0.0	0.0
Detector 1 Delay (s)	0.0	0.0	0.0	0.0	0.0	0.0	0.0	0.0	0.0	0.0	0.0
Detector 2 Position (ft)	94	94	94	94	94	94	94	94	94	94	94
Detector 2 Size (ft)	6	6	6	6	6	6	6	6	6	6	6
Detector 2 Type	Ch+Ex	Ch+Ex	Ch+Ex	Ch+Ex	Ch+Ex	Ch+Ex	Ch+Ex	Ch+Ex	Ch+Ex	Ch+Ex	Ch+Ex
Detector 2 Channel	0.0	0.0	0.0	0.0	0.0	0.0	0.0	0.0	0.0	0.0	0.0
Detector 2 Extend (s)	pm+pt	NA	pm+pt	NA	pm+pt	NA	pm+pt	NA	pm+pt	NA	NA
Turn Type	3	8	7	4	4	4	5	2	1	6	6
Protected Phases	8	8	4	4	4	4	2	2	6	6	6
Permitted Phases	3	8	7	4	4	4	5	2	1	6	6
Detector Phase											

Lanes, Volumes, Timings SRF & Associates Synchro 8 Report Page 11

Union Road Corridor Study 2026 Design Conditions (With Road Diet) - PM Peak Hour
5: Union Road & Main Street

1/16/2017

Lane Group	EBL	EBT	EBL	WBL	WBT	WBR	NBL	NBT	NBR	SBL	SBR
Switch Phase	3.0	10.0	3.0	10.0	3.0	10.0	3.0	20.0	3.0	20.0	3.0
Minimum Initial (s)	8.0	33.5	8.0	32.3	8.0	32.3	8.0	32.4	8.0	32.4	8.0
Minimum Split (s)	15.0	25.0	15.0	25.0	15.0	25.0	15.0	110.0	15.0	110.0	15.0
Total Split (s)	9.4%	15.6%	9.4%	15.6%	9.4%	15.6%	6.3%	68.8%	6.3%	68.8%	6.3%
Total Split (%)	10.4	19.7	10.4	19.7	10.4	19.7	5.1	104.6	5.1	104.6	5.1
Maximum Green (s)	3.6	3.6	3.6	3.6	3.6	3.6	3.9	3.9	3.9	3.9	3.9
Yellow Time (s)	1.0	1.7	1.0	1.7	1.0	1.7	1.0	1.5	1.0	1.5	1.0
All-Red Time (s)	0.0	0.0	0.0	0.0	0.0	0.0	0.0	0.0	0.0	0.0	0.0
Lost Time Adjust (s)	4.6	5.3	4.6	5.3	4.6	5.3	4.9	5.4	4.9	5.4	4.9
Total Lost Time (s)	Lead/Lag	Lead	Lag	Lead	Lag	Lead	Lag	Lead	Lag	Lead	Lag
Lead/Lag	Yes	Yes	Yes	Yes	Yes	Yes	Yes	Yes	Yes	Yes	Yes
Lead-Lag Optimize?	3.0	2.0	3.0	2.0	3.0	2.0	2.0	4.0	2.0	4.0	2.0
Vehicle Extension (s)	None	None	None	None	None	None	None	C-Min	None	C-Min	None
Recall Mode	7.0	7.0	7.0	7.0	7.0	7.0	7.0	7.0	7.0	7.0	7.0
Walk Time (s)	20.0	20.0	20.0	20.0	20.0	20.0	20.0	20.0	20.0	20.0	20.0
Flash Dont Walk (s)	0	0	0	0	0	0	0	0	0	0	0
Pedestrian Calls (#/hr)	28.6	19.6	24.4	15.7	113.6	104.6	115.8	105.7	115.8	105.7	115.8
Act Effct Green (s)	0.18	0.12	0.15	0.10	0.71	0.65	0.72	0.66	0.72	0.66	0.72
Actuated g/C Ratio	0.46	0.75	0.22	0.64	0.75	1.03	1.08	1.30	1.08	1.30	1.08
v/c Ratio	61.4	77.5	54.4	72.3	61.8	62.8	135.8	160.7	135.8	160.7	135.8
Control Delay	0.0	0.0	0.0	0.0	0.0	0.0	0.0	24.3	0.0	0.0	0.0
Queue Delay	61.4	77.5	54.4	72.3	61.8	62.8	135.8	160.7	135.8	160.7	135.8
Total Delay	E	E	D	E	E	E	F	F	F	F	F
LOS	E	E	D	E	E	E	F	F	F	F	F
Approach Delay	72.1	68.2	72.1	68.2	72.1	68.2	72.1	68.2	72.1	68.2	72.1
Approach LOS	E	E	E	E	E	E	F	F	F	F	F

Intersection Summary
Area Type: Other
Cycle Length: 160
Actuated Cycle Length: 160
Offset: 0 (0%) Referenced to phase 2:NBLT and 6:SBTL, Start of Green
Natural Cycle: 145
Control Type: Actuated-Coordinated
Maximum v/c Ratio: 1.30
Intersection Signal Delay: 119.7
Intersection Capacity Utilization 108.6%
Analysis Period (min) 15



Lanes, Volumes, Timings SRF & Associates Synchro 8 Report Page 12

Union Road Corridor Study 2026 Design Conditions (With Road Diet) - PM Peak Hour
6: Union Road & Seneca Street 1/16/2017

Lane Group	EBL	EBT	WBL	WBT	WBR	NBL	NBT	NBR	SBL	SBR
Lane Configurations	↔	↔	↔	↔	↔	↔	↔	↔	↔	↔
Volume (vph)	259	251	134	178	211	55	103	787	121	149
Ideal Flow (vphpl)	1900	1900	1900	1900	1900	1900	1900	1900	1900	1900
Storage Length (ft)	175	0	115	0	130	0	160	0	160	0
Storage Lanes	1	0	1	0	1	0	1	0	1	0
Taper Length (ft)	150	0	110	0	95	0	115	0	115	0
Lane Util. Factor	1.00	0.95	1.00	0.95	1.00	0.95	0.95	1.00	0.95	0.95
Flt Permitted	0.948	0.948	0.950	0.969	0.950	0.980	0.984	0.984	0.984	0.984
Satd. Flow (prot)	1770	3355	0	1770	3429	0	1770	3468	0	1770
Flt Permitted	0.382	0.230	0.055	0.055	0.055	0.196	0.196	0.196	0.196	0.196
Satd. Flow (perm)	712	3355	0	428	3429	0	102	3468	0	365
Right Turn on Red	Yes	Yes	Yes	Yes	Yes	Yes	Yes	Yes	Yes	Yes
Satd. Flow (RTOR)	61	20	20	35	45	16	13	40	40	40
Link Speed (mph)	35	35	35	35	35	35	35	35	35	35
Link Distance (ft)	1121	21.8	6.9	21.2	1399	618	10.5	10.5	10.5	10.5
Travel Time (s)	0.80	0.80	0.93	0.93	0.91	0.91	0.91	0.91	0.90	0.90
Peak Hour Factor	324	314	168	191	227	59	113	865	133	166
Shared Lane Traffic (%)	0.80	0.80	0.93	0.93	0.91	0.91	0.91	0.91	0.90	0.90
Adj. Flow (vph)	324	482	0	191	286	0	113	998	0	166
Lane Group Flow (vph)	No	No	No	No	No	No	No	No	No	No
Enter Blocked Intersection	Left	Left	Right	Right	Left	Left	Left	Right	Left	Right
Lane Alignment	Left	Left	Right	Right	Left	Left	Left	Right	Left	Right
Median Width(ft)	12	12	12	12	12	12	12	12	12	12
Link Offset(ft)	0	0	0	0	0	0	0	0	0	0
Crosswalk Width(ft)	16	16	16	16	16	16	16	16	16	16
Two way Left Turn Lane	Yes	Yes	Yes	Yes	Yes	Yes	Yes	Yes	Yes	Yes
Headway Factor	1.00	1.00	1.00	1.00	1.00	1.00	1.00	1.00	1.00	1.00
Turning Speed (mph)	15	9	15	15	9	15	15	9	15	15
Number of Detectors	1	2	1	2	1	2	1	2	1	2
Detector Template	Left	Thru	Left	Thru	Left	Thru	Left	Thru	Left	Thru
Leading Detector (ft)	20	100	20	100	20	100	20	100	20	100
Trailing Detector (ft)	0	0	0	0	0	0	0	0	0	0
Detector 1 Position(ft)	0	0	0	0	0	0	0	0	0	0
Detector 1 Size(ft)	20	6	20	6	20	6	20	6	20	6
Detector 1 Type	Ch+Ex	Ch+Ex	Ch+Ex	Ch+Ex	Ch+Ex	Ch+Ex	Ch+Ex	Ch+Ex	Ch+Ex	Ch+Ex
Detector 1 Channel	Ch+Ex	Ch+Ex	Ch+Ex	Ch+Ex	Ch+Ex	Ch+Ex	Ch+Ex	Ch+Ex	Ch+Ex	Ch+Ex
Detector 1 Extend (s)	0.0	0.0	0.0	0.0	0.0	0.0	0.0	0.0	0.0	0.0
Detector 1 Queue (s)	0.0	0.0	0.0	0.0	0.0	0.0	0.0	0.0	0.0	0.0
Detector 1 Delay (s)	0.0	0.0	0.0	0.0	0.0	0.0	0.0	0.0	0.0	0.0
Detector 2 Position(ft)	94	94	94	94	94	94	94	94	94	94
Detector 2 Size(ft)	6	6	6	6	6	6	6	6	6	6
Detector 2 Type	Ch+Ex	Ch+Ex	Ch+Ex	Ch+Ex	Ch+Ex	Ch+Ex	Ch+Ex	Ch+Ex	Ch+Ex	Ch+Ex
Detector 2 Channel	Ch+Ex	Ch+Ex	Ch+Ex	Ch+Ex	Ch+Ex	Ch+Ex	Ch+Ex	Ch+Ex	Ch+Ex	Ch+Ex
Detector 2 Extend (s)	0.0	0.0	0.0	0.0	0.0	0.0	0.0	0.0	0.0	0.0
Turn Type	pm+pt	NA	pm+pt	NA	pm+pt	NA	pm+pt	NA	pm+pt	NA
Protected Phases	7	4	3	8	5	2	1	6	1	6
Permitted Phases	4	8	8	2	2	6	6	6	6	6
Detector Phase	7	4	3	8	5	2	1	6	1	6

Union Road Corridor Study 2026 Design Conditions (With Road Diet) - PM Peak Hour
6: Union Road & Seneca Street 1/16/2017

Lane Group	EBL	EBT	WBL	WBT	WBR	NBL	NBT	NBR	SBL	SBR
Switch Phase	↔	↔	↔	↔	↔	↔	↔	↔	↔	↔
Minimum Initial (s)	3.0	10.0	3.0	10.0	3.0	3.0	20.0	3.0	3.0	20.0
Minimum Split (s)	8.0	32.3	8.0	32.3	8.0	8.0	28.5	8.0	8.0	28.5
Total Split (s)	20.0	30.0	20.0	30.0	20.0	20.0	70.0	20.0	20.0	70.0
Total Split (%)	14.3%	21.4%	14.3%	21.4%	14.3%	14.3%	50.0%	14.3%	14.3%	50.0%
Maximum Green (s)	15.7	24.7	15.7	24.7	15.7	64.5	15.7	64.5	15.7	64.5
Yellow Time (s)	3.2	3.6	3.2	3.6	3.2	4.3	3.2	4.3	3.2	4.3
All-Red Time (s)	1.1	1.7	1.1	1.7	1.1	1.2	1.1	1.2	1.1	1.2
Lost Time Adjust (s)	0.0	0.0	0.0	0.0	0.0	0.0	0.0	0.0	0.0	0.0
Total Lost Time (s)	4.3	5.3	4.3	5.3	4.3	5.5	4.3	5.5	4.3	5.5
Lead/Lag	Lead	Lag	Lead	Lag	Lead	Lag	Lead	Lag	Lead	Lag
Lead-Lag Optimize?	Yes	Yes	Yes	Yes	Yes	Yes	Yes	Yes	Yes	Yes
Vehicle Extension (s)	2.0	4.0	2.0	4.0	2.0	4.0	2.0	4.0	2.0	4.0
Recall Mode	None	None	None	None	None	None	C-Min	None	C-Min	C-Min
Walk Time (s)	7.0	7.0	7.0	7.0	7.0	7.0	7.0	7.0	7.0	7.0
Flash Dont Walk (s)	20.0	20.0	20.0	20.0	20.0	16.0	16.0	16.0	16.0	16.0
Pedestrian Calls (#/hr)	0	0	0	0	0	0	0	0	0	0
Act Effct Green (s)	40.6	24.1	36.9	21.5	82.6	72.1	84.1	72.9	84.1	72.9
Actuated g/C Ratio	0.29	0.17	0.26	0.15	0.59	0.52	0.60	0.52	0.60	0.52
v/c Ratio	0.97	0.77	0.76	0.53	0.66	0.56	0.52	0.56	0.52	0.56
Control Delay	85.4	57.1	57.5	53.6	43.8	24.8	17.4	35.3	17.4	35.3
Queue Delay	0.0	0.0	0.0	0.0	0.0	0.0	0.0	0.0	0.0	0.0
Total Delay	85.4	57.1	57.5	53.6	43.8	24.8	17.4	35.3	17.4	35.3
LOS	F	E	E	D	D	C	C	B	B	D
Approach Delay	68.4	55.1	55.1	55.1	55.1	26.8	26.8	26.8	26.8	33.6
Approach LOS	E	E	E	E	E	C	C	C	C	C

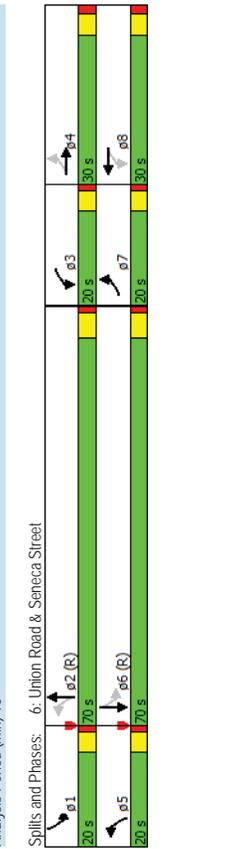

Union Road Corridor Study 2026 Design Conditions (With Road Diet) - PM Peak Hour
7: Union Road & Southgate Plaza/Willowdale Drive

1/16/2017

Lane Group	EBL	EBT	EBR	WBL	WBT	WBR	NBL	NBT	NBR	SBL	SBR
Lane Configurations	101	28	153	21	11	4	156	764	11	8	1244
Volume (vph)	1900	1900	1900	1900	1900	1900	1900	1900	1900	1900	1900
Ideal Flow (vpph)	65	0	0	0	0	70	0	50	0	50	0
Storage Length (ft)	1	0	0	0	0	1	0	1	0	1	0
Storage Lanes	25	0	0	25	0	25	0	100	0	100	0
Taper Length (ft)	1.00	1.00	1.00	1.00	1.00	1.00	1.00	0.95	0.95	1.00	0.95
Lane Util. Factor	0.873			0.985		0.971		0.998		0.950	0.997
Flt Protected	0.950			0.971		0.950		0.950		0.950	0.950
Satd. Flow (prot)	1770	1626	0	1782	0	1770	3532	0	1770	3529	0
Flt Permitted	0.804			0.463		0.106		0.269		0.269	
Satd. Flow (perm)	1498	1626	0	850	0	197	3532	0	501	3529	0
Right Turn on Red		Yes		Yes		Yes		Yes		Yes	
Satd. Flow (RTOR)	163			6		2		4		4	
Link Speed (mph)	15			30		45		45		45	
Link Distance (ft)	325			582		648		1399		1399	
Travel Time (s)	14.8			13.2		9.8		21.2		21.2	
Peak Hour Factor	0.94	0.94	0.94	0.57	0.57	0.89	0.89	0.89	0.89	0.92	0.92
Shared Lane Traffic (%)	107	30	163	37	19	7	175	858	12	9	1352
Adj. Flow (vph)	107	193	0	0	63	0	175	870	0	9	1382
Lane Group Flow (vph)	No	No	No	No	No	No	No	No	No	No	No
Enter Blocked Intersection	Left	Left	Right	Left	Right	Left	Left	Right	Left	Right	Right
Lane Alignment	12	12	12	12	12	12	12	12	12	12	12
Median Width(ft)	0	0	0	0	0	0	0	0	0	0	0
Link Offset(ft)	16			16		16		16		16	
Crosswalk Width(ft)	1.00	1.00	1.00	1.00	1.00	1.00	1.00	1.00	1.00	1.00	1.00
Headway Factor	15	9	15	1	2	9	15	9	15	15	9
Turning Speed (mph)	1	2	1	Thru	Thru	Left	Thru	Left	Thru	Left	Thru
Number of Detectors	20	100	20	100	20	100	20	100	20	100	20
Detector Template	0	0	0	0	0	0	0	0	0	0	0
Leading Detector (ft)	0	0	0	0	0	0	0	0	0	0	0
Trailing Detector (ft)	20	6	20	6	20	6	20	6	20	6	20
Detector 1 Position(ft)	Ch+Ex	Ch+Ex	Ch+Ex	Ch+Ex	Ch+Ex	Ch+Ex	Ch+Ex	Ch+Ex	Ch+Ex	Ch+Ex	Ch+Ex
Detector 1 Size(ft)	0.0	0.0	0.0	0.0	0.0	0.0	0.0	0.0	0.0	0.0	0.0
Detector 1 Channel	0.0	0.0	0.0	0.0	0.0	0.0	0.0	0.0	0.0	0.0	0.0
Detector 1 Extend (s)	0.0	0.0	0.0	0.0	0.0	0.0	0.0	0.0	0.0	0.0	0.0
Detector 1 Queue (s)	0.0	0.0	0.0	0.0	0.0	0.0	0.0	0.0	0.0	0.0	0.0
Detector 1 Delay (s)	0.0	0.0	0.0	0.0	0.0	0.0	0.0	0.0	0.0	0.0	0.0
Detector 2 Position(ft)	94			94		94		94		94	
Detector 2 Size(ft)	6			6		6		6		6	
Detector 2 Type	Ch+Ex			Ch+Ex		Ch+Ex		Ch+Ex		Ch+Ex	
Detector 2 Channel	0.0			0.0		0.0		0.0		0.0	
Detector 2 Extend (s)	Perm	NA	Perm	NA	pm+pt	NA	Perm	NA	Perm	NA	NA
Turn Type	3	3	3	3	3	3	3	3	3	3	3
Protected Phases	3	3	3	3	3	3	3	3	3	3	3
Permitted Phases	3	3	3	3	3	3	3	3	3	3	3
Detector Phase											

Lanes, Volumes, Timings SRF & Associates Synchro 8 Report Page 17

Union Road Corridor Study 2026 Design Conditions (With Road Diet) - PM Peak Hour
7: Union Road & Southgate Plaza/Willowdale Drive

1/16/2017

Lane Group	EBL	EBT	EBR	WBL	WBT	WBR	NBL	NBT	NBR	SBL	SBR
Switch Phase	6.0	6.0	6.0	6.0	6.0	6.0	3.0	20.0	20.0	20.0	20.0
Minimum Initial (s)	32.3	32.3	32.3	32.3	32.3	32.3	8.0	25.5	25.5	25.5	25.5
Minimum Split (s)	20.0	20.0	20.0	20.0	20.0	20.0	15.0	55.0	55.0	55.0	55.0
Total Split (s)	22.2%	22.2%	22.2%	22.2%	22.2%	22.2%	16.7%	61.1%	61.1%	61.1%	61.1%
Total Split (%)	14.7	14.7	14.7	14.7	14.7	14.7	10.7	49.5	49.5	49.5	49.5
Maximum Green (s)	3.6	3.6	3.6	3.6	3.6	3.6	3.2	4.3	4.3	4.3	4.3
Yellow Time (s)	1.7	1.7	1.7	1.7	1.7	1.7	1.1	1.2	1.2	1.2	1.2
All-Red Time (s)	0.0	0.0	0.0	0.0	0.0	0.0	0.0	0.0	0.0	0.0	0.0
Lost Time Adjust (s)	5.3	5.3	5.3	5.3	5.3	5.3	4.3	5.5	5.5	5.5	5.5
Total Lost Time (s)	LeadLag			LeadLag		LeadLag		LeadLag		LeadLag	
Lead-Lag Optimize?	3.0	3.0	3.0	3.0	3.0	3.0	2.0	4.0	4.0	4.0	4.0
Vehicle Extension (s)	None	None	None	None	None	None	C-Max	Min	Min	Min	Min
Recall Mode	7.0	7.0	7.0	7.0	7.0	7.0					
Walk Time (s)	20.0	20.0	20.0	20.0	20.0	20.0					
Flash Dont Walk (s)	0	0	0	0	0	0					
Pedestrian Calls (#/hr)	11.7	11.7	11.7	11.7	11.7	11.7	64.4	48.9	48.9	48.9	48.9
Act Effct Green (s)	0.13	0.13	0.13	0.13	0.13	0.13	0.72	0.54	0.54	0.54	0.54
Actuated g/C Ratio	0.55	0.55	0.55	0.55	0.55	0.55	0.45	0.03	0.03	0.03	0.03
v/c Ratio	46.7	14.8	14.8	50.6	50.6	50.6	13.3	13.2	9.9	17.9	17.9
Control Delay	0.0	0.0	0.0	0.0	0.0	0.0	0.0	0.0	0.0	0.0	0.0
Queue Delay	46.7	14.8	14.8	50.6	50.6	50.6	13.3	13.2	9.9	17.9	17.9
Total Delay	D	B	D	D	D	D	B	B	A	B	B
LOS	Approach Delay			26.2		50.6		13.3		17.9	
Approach LOS	C			D		D		B		B	
Intersection Summary	Other										
Area Type:	Other										
Cycle Length:	90										
Actuated Cycle Length:	90										
Offset:	75 (83%), Referenced to phase 1:NBL, Start of Green										
Natural Cycle:	90										
Control Type:	Actuated-Coordinated										
Maximum v/c Ratio:	0.72										
Intersection Signal Delay:	17.8										
Intersection Capacity Utilization:	76.3%										
Analysis Period (min):	15										

Lanes, Volumes, Timings SRF & Associates Synchro 8 Report Page 18